

Risk Assessment of a
LM117 Voltage Regulator Circuit Design
Using Crystal Ball and Minitab
(Part 1)

By
Andrew G. Bell

31 August, 2006

Table of Contents

| | |
|-------------------------------------------------------------------------------|----|
| Executive Summary | 2 |
| Introduction | 3 |
| Design Requirements | 4 |
| Initial Design – Nominal Performance | 5 |
| Case 1 - Design Risk Assessment – Classical Factor Distributions | 6 |
| Case 2 - Design Risk Assessment – Subtracted $\pm 0.1\%$ Resistor Range | 8 |
| Case 3 - Design Risk Assessment – Using Element Distributions | 9 |
| Conclusion | 12 |
| Appendix A | 13 |
| Appendix B | 15 |
| Appendix C..... | 19 |
| Appendix D..... | 20 |
| Appendix E..... | 23 |
| Appendix F..... | 28 |

Table of Figures and Tables

| | |
|----------------|----|
| Figure 1 | 2 |
| Figure 2 | 3 |
| Figure 3 | 7 |
| Figure 4 | 8 |
| Figure 5 | 9 |
| Figure 6 | 10 |
| Figure 7 | 11 |
| Figure 8 | 11 |
| Table 1 | 2 |
| Table 2 | 6 |
| Table 3 | 6 |
| Table 4 | 8 |
| Table 5 | 9 |
| Table 6 | 10 |
| Table 7 | 10 |

Table of Equations

| | |
|-------------------|---|
| Equation #1 | 3 |
| Equation #2 | 6 |
| Equation #3 | 6 |
| Equation #4 | 6 |

Executive Summary

Risk Assessment (Worst Case Analysis) of electronic circuits today typically use circuit simulation tools like PSPICE and Excel to verify that the design will meet the design requirements worst case. Tolerances of component parameters are determined based upon how parts will vary as a function of purchase variation, aging degradation and temperature induced changes. These variations are included into device models and Monte Carlo and/or Sensitivity Worst Case Analysis are performed. The quality of the design (risk assessment) is measured based upon whether the simulated results stay within the design requirements.

The present approach typically ignores or assumes component parameter distributions and lumps parameter limits into three major categories: EVA, RSS or 1 sigma (1σ). This paper will evaluate the classical approach against two alternate approaches (RSS - $\pm 0.1\%$ and Combined) to determine the corresponding design risks.

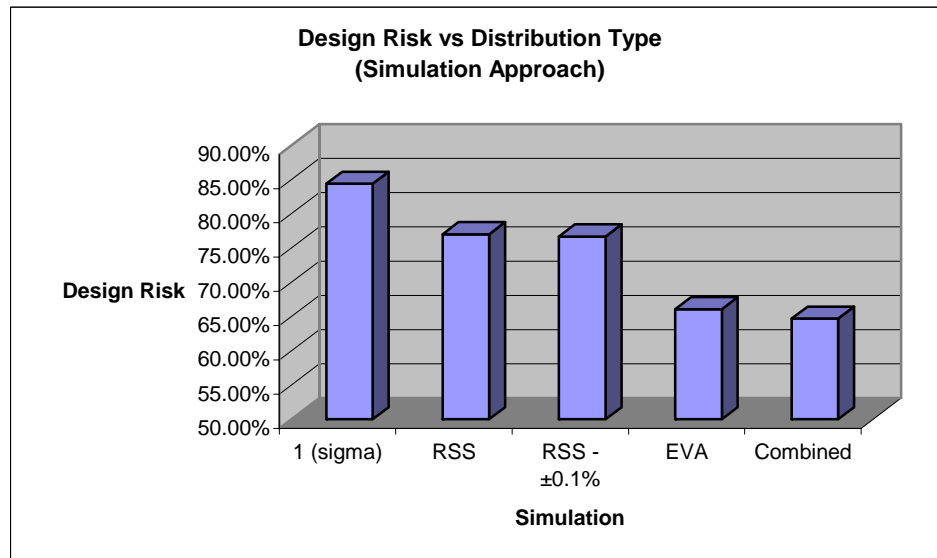

Figure 1
Design Risk vs Distribution Types

A new simulation tool called “Crystal Ball” is used in this paper to demonstrate how a LM117 adjustable linear regulator design can be evaluated using the five approaches shown in Figure 1. Also, Minitab will be used to evaluate the quality of the design. Results show that the new approach provides more insight into the quality of the design and provides some insight into possible design improvements through the use of the new simulation tools.

Introduction

There are four factors which govern the value of the output voltage of an adjustable LM117¹ linear regulator shown in Figure 2. They are the: two set point resistors, R1 and R2, the voltage reference, V_{REF}, and the adjust pin current, I_{adj}. Variation in these four factors due to purchase variations, temperature and aging will influence the variability of the output voltage.

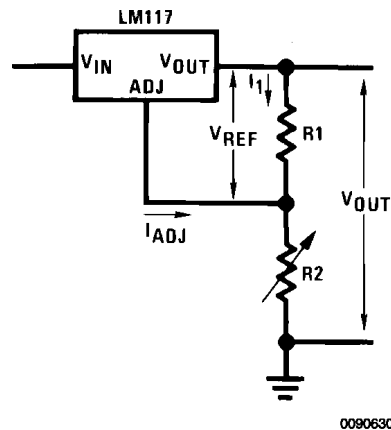

Figure 2 Typical Adjustable Voltage Regulator Configuration

The relationship between the four factors relative to output voltage is defined in the following equation.

$$V_{OUT} = V_{REF} \left(1 + \frac{R2}{R1} \right) + I_{ADJ}R2 \quad \text{Equation \#1}$$

This paper will assess the design risk of the regulator circuit to meet upper and lower specification limits when the four factors are varied based on distributions for each factor. A comparison of design risks will be made between conventionally assumed factor distributions against composite factor distributions which are composed of element distributions for purchase, temperature and aging.

For convenience the following terms will be used throughout this paper:

A *factor* is one of the four control elements that determine the regulator circuit's output voltage: R1, R2, V_{ref} or I_{adj} and is governed by equation #1.

A *factor distribution* is the probability curve associated with one of the factors.

An *element distribution* is the probability curve associated with either purchase, temperature or aging induced variations. When combined element distributions create a factor distribution.

¹ LM117 Datasheet <http://www.national.com/ds/LM/LM117.pdf>, National Semiconductor

Three cases will be presented in this paper. The first case will include three simulations using equation #1 and typical distributions that are used in the industry² for the four control factors. The second case will be a single simulation that will use typical distributions but will exclude a $\pm 0.1\%$ range around the nominal value of the 1% resistors. The third case will use element distributions which are based upon best estimates of distributions for purchase, temperature and aging variations for the four factor elements. The combination of the element distributions into a composite factor distribution will be performed by the simulation software. All simulations used a 10,000 run Monte Carlo using Crystal Ball³. All cases will use a common electronic circuit for distribution evaluation (Figure 2 and Equation #1).

Case 1:

The first simulation used factor distributions with an EVA (extreme value analysis) normal distribution. The $\pm 3\sigma$ were set equal to the extreme values for the four factors. This simulation will be referred to as the *EVA simulation*. The second simulation for the first case used normal distributions where the factor element distributions are RSS (root-sum-squared) together. The $\pm 3\sigma$ limits are set equal to the RSS value of the extremes variations caused by purchase variations, temperature and aging. This simulation will be referred to as the *RSS simulation*. (A sensitivity analysis was also performed for this simulation.) The third simulation used the EVA limits and divided them by three as the $\pm 3\sigma$ limits. Uniform distributions were used for the four factors. This simulation will be referred to as the *1 σ simulation*.

Case 2:

Only one simulation was performed for this case. A normal distribution was used for the resistors with the center $\pm 0.1\%$ range around the nominal value of the 1% resistors subtracted. When resistors are manufactured sometimes the vendor will screen tighter tolerance parts from the same resistor batch. This process will leave a void in the distribution around the nominal value. This simulation case evaluates the significance of the void on the worst case performance of the circuit. This simulation will be referred to as the *RSS – ($\pm 0.1\%$) simulation*.

Case 3:

Again only one Crystal Ball simulation was performed for this case. Best estimate distributions were created for each element distribution. For purchase variations distribution the assumption is to use normal distributions with the $\pm 3\sigma$ limits set to the maximum and minimum tolerances. Temperature induced parameter variations are assumed to be uniform based on the concept that any temperature between the maximum and minimum temperature are equally likely. The maximum and minimum temperature

² A Comparison of Tolerance Analysis Methods by Steven M. Sandler, AEi Sysyems, LLC

³ Crystal Ball is a software simulation tool from Decisioneering, Inc

variations are based on the maximum and minimum variation at the temperature extremes. Changes due to age are assumed to follow the Arrhenius Equation. This distribution follows the classical “bathtub” shape curve. Both a Crystal Ball simulation and Minitab⁴ analysis are used to evaluate the simulation results. Crystal Ball is used to develop the element distributions and run the Monte Carlo simulation. Minitab is used to evaluate the simulation results using Cp and Cpk values which are process capability measurements and Xbar and R Control Charts which measure the process variation measurements. This simulation will be referred to as the *Combined simulation*.

Design Requirements

A 5VDC regulated voltage is required which can regulate +9VDC to +5VDC $\pm 2.5\%$. To verify that the design will meet the requirements a risk assessment (worst case analysis) must be performed to demonstrate performance. (All three cases will study the performance of this design.)

The design must regulate to the desired voltage after five years of use and in an environment of -25°C to +75°C. The output load will be 100mA and the input voltage will be 9VDC.

The design will use standard available parts and no tailoring will be allowed.

Initial Design – Nominal Performance

The 5VDC regulator circuit will be designed using equation #1 which describes how the circuit shown in Figure 2 functions. The resistors that will be used are M55342 type surface mount resistors which have a $\pm 1\%$ tolerance and have been used in other designs.

To facilitate the design Equation #1 has been entered into an Excel spreadsheet along with the nominal values of Vref and Iadj. Then available 1% M55342⁵ resistors values for R1 and R2 have been entered into a table which calculates every possible Vout value based upon the available resistors and nominal values of Vref and Iadj. A selection of R1 and R2 values were then made based on the values which produced the closes results to the desired 5VDC regulated output voltage. Three candidate value sets were selected based on closeness to the target value with the primary selection being shown in Table 1. (Please see [Appendix A - LM117 Datasheet Information](#) and [Supplemental Design Details](#) for more information about the initial design.)

| | |
|--------|----------|
| Vref = | 1.25 |
| R1 = | 2.00E+03 |
| R2 = | 5.56E+03 |
| Iadj = | 50.0E-6 |
| Vout = | 5.00 |

Table 1
Initial Design

⁴ Minitab is a statistical software form Minitab, Inc.

⁵ MIL-PRF-55342G

Case 1 - Design Risk Assessment – Classical Factor Distributions

Classical techniques⁶ suggest that design risk can be evaluated using either an RSS, EVA or 1σ approach. These three approaches can be summarized using Equation #2, #3 and #4

$$RSS = \sqrt{purchase_tol^2 + temperature_tol^2 + aging_tol^2} \quad \text{Equation \#2}$$

$$EVA = \sum (purchase_tol + temperature_tol + aging_tol) \quad \text{Equation \#3}$$

$$1\sigma = EVA/3 \quad \text{Equation \#4}$$

Using these equations and parameter information defined in Appendix A the four factors of interest can be calculated and are summarized in Table 2.

| | RSS | | EVA | | 1 sigma | |
|---------------|---------|----------|---------|----------|---------|---------|
| | tol | max | tol | max | min | max |
| Vref = | 4.48% | 1.31 | 6.30% | 1.33 | 1.22 | 1.28 |
| R1 = | 1.22% | 2,024 | 2.00% | 2,040 | 1,987 | 2,013 |
| R2 = | 1.22% | 5,628 | 2.00% | 5,671 | 5,523 | 5,597 |
| Iadj = | 100.79% | 100.4E-6 | 112.62% | 106.3E-6 | 31.2E-6 | 68.8E-6 |

Table 2
Factor Tolerances to include Purchase,
Temperature and Aging Induced Variations

Using the values defined in Table 2 three 10,000 sample simulations of Equation #1 using classical distributions were run. The results are shown in Table 3 with more details provided in Appendix B. As can be seen the *EVA simulation* produces the largest variance and the smallest likelihood that the design will meet the design requirements. While the *1σ simulation* shows the smallest variance and highest likelihood that the requirements can be met.

| | Vout Performance | | |
|--------------|------------------|--------|--------|
| | RSS | EVA | 1σ |
| Mean = | 5.001 | 5.001 | 5.002 |
| Stdev = | 0.104 | 0.129 | 0.085 |
| Max = | 5.384 | 5.478 | 5.238 |
| Min = | 4.611 | 4.546 | 4.770 |
| Certiantiy = | 77.03% | 66.06% | 84.39% |

Table 3
Simulation Results for 10,000 sample Monte Carlo
Using Crystal Ball and RSS, EVA and 1σ Approaches

⁶ Worst case circuit analysis-an overview (electronic parts/circuits tolerance analysis) Smith, W.M.; Reliability and Maintainability Symposium, 1996 Proceedings. 'International Symposium on Product Quality and Integrity', Annual 22-25 Jan. 1996 Page(s):326 - 334

So the question becomes, which approach is the right approach to use to evaluate the design risk? There is nearly a 20% spread between the most optimistic and most pessimistic approaches. Both are used in industry and both are “right”. What is different is the use of a tool, Crystal Ball, which will allow for a more thorough evaluation of the distribution assumptions.

The Sensitivity results of the RSS simulation is shown Figure 3 and suggests that the majority of the most significant factors are the LM117 Iadj and Vref. Little can be done to desensitize the design to variations in these two factors. This paper will really focus on how distributions influence the design risk so no other Sensitivity Analysis will be done.

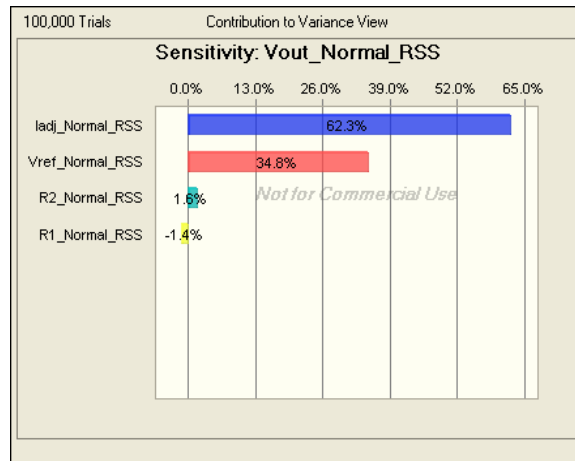

Figure 3
Sensitivity Results for
Case 1 RSS Simulation

Case 2 - Design Risk Assessment – Subtracted $\pm 0.1\%$ Resistor Range

Case 2 compares the *RSS Simulation* that was developed in Case 1 with a RSS simulation with the middle $\pm 0.1\%$ around the mean for both R1 and R2 distributions subtracted out, as shown in Figure 4. It has long been considered that possible resistor distributions could have an impact on the quality of a design. However, a comparison between the two simulations, summarized in Table 4, shows that there is little to no difference between the risk assessment of the design with or without the subtracted $\pm 0.1\%$ around the resistor means.

| | Vout Performance | |
|-------------|------------------|-----------------------|
| | RSS | RSS - ($\pm 0.1\%$) |
| Mean = | 5.001 | 5.004 |
| Stdev = | 0.104 | 0.105 |
| Max = | 5.384 | 5.430 |
| Min = | 4.611 | 4.620 |
| Ceriantiy = | 77.03% | 76.70% |

Table 4
Comparison between RSS and
RSS - $\pm 0.1\%$ Resistor Range

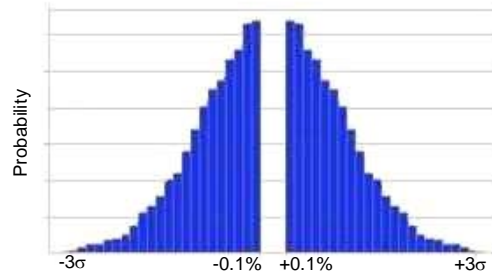

Figure 4
Typical Resistor Distribution
With $\pm 0.1\%$ Gap

Additional simulation results for the on Case 2 can be found in Appendix C.

Case 3 - Design Risk Assessment – Using Element Distributions

As a final consideration a simulation was performed using distributions which are based on best estimates of spread. Ideally, it would be prudent to know what the particular distribution is for each factor and each environmental or purchase condition. However, this information may not be available. Table 5 summarizes the individual element distributions used. Additional information can be found in Appendices D and E.

| | Purchase | | | | Temp | | | Aging | | |
|--------|----------|---------|----------|------|---------|---------|--------|---------|---------|-------|
| | min | nom | max | tol | min | max | tol | min | max | tol |
| Vref = | 1.200 | 1.250 | 1.300 | 4% | 1.2463 | 1.2537 | 0.30% | 1.2250 | 1.2750 | 2% |
| R1 = | 1,980.0 | 2,000 | 2,020.0 | 1% | 1,990.0 | 2,010.0 | 0.50% | 1,990.0 | 2,010.0 | 0.50% |
| R2 = | 5,504.4 | 5,560 | 5,615.6 | 1% | 5,532.2 | 5,587.8 | 0.50% | 5,532.2 | 5,587.8 | 0.50% |
| Iadj = | 0 | 50.0E-6 | 100.0E-6 | 100% | 43.7E-6 | 56.3E-6 | 12.62% | | | 0% |
| Temp = | | | | | -25 | 75 | | | | |

Table 5
Element Distributions Values
For Combined Simulation

Since purchase tolerance is typically assumed to be normally distributed this will be applied to all purchase distributions for the four factors. However, temperature is more uniform in distribution because each temperature is equally likely over the temperature range. Thus a uniform distribution will be used for temperature variations for all four factors. Variation due to age follows a “bathtub” shape distribution, shown on Figure 5, based on the Arrhenius Equation⁷. Only three of the four control factors exhibit aging degradation so the Iadj factor will not include a tolerance for aging.

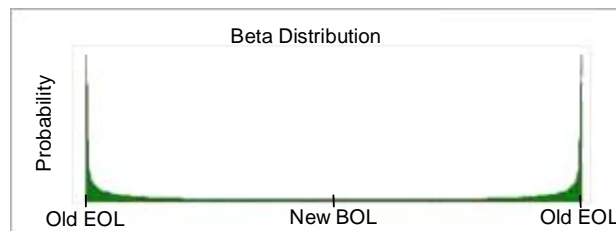

Figure 5
Typical Aging Distribution

⁷ The Aging Behavior of Commercial Thick-Film Resistors, Sinnadurai, N.; Wilson, K.; Components, Hybrids, and Manufacturing Technology, IEEE Transactions on [see also IEEE Trans. on Components, Packaging, and Manufacturing Technology, Part A, B, C] Volume 5, Issue 3, Sep 1982 Page(s):308 - 317

The element distributions are combined using the equations defined in Tables 6 and 78 for the F2 to F6 cells. Four Define Forecast cells are used to calculate the variations for purchase (C6), temperature (D6), aging (E6), and the combined effects (F6). The *Combined simulation* results (see Figure 6 and Appendix E) show that there is a 64.7% probability that the design will meet the design requirements using “realistic” element distributions. This is slightly worse than was predicted by the *EVA simulation* determined in Case 1 and would suggest that the Combined Simulation is the most conservative approach.

| Excel Equations | |
|-----------------|--------------------------------------------------|
| F2 | $B2 + ((C2 - 1.25) + (D2 - 1.25) + (E2 - 1.25))$ |
| F3 | $B3 + ((C3 - 2000) + (E3 - 2000) + (E3 - 2000))$ |
| F4 | $B4 + ((C4 - 5560) + (D4 - 5560) + (E4 - 5560))$ |
| F5 | $B5 + ((C5 - 50e-6) + (D5 - 50e-6))$ |
| F6 | $F3 * (1 + F5/F4) + (F6 * F5)$ |
| E6 | $E3 * (1 + E5/E4) + (E6 * E5)$ |
| D6 | $D3 * (1 + D5/D4) + (D6 * D5)$ |
| C6 | $C3 * (1 + C5/C4) + (C6 * C5)$ |

Table 6
Excel Equations for
Crystal Ball Define Cells

| | A | B | C | D | E | F |
|---|--------|---------|----------|---------|---------|---------|
| 1 | | | Purchase | Temp | Aging | |
| 2 | Vref = | 1.25 | 1.25 | 1.25 | 1.25 | 1.25 |
| 3 | R1 = | 2,000 | 2,000 | 2,000 | 2,000 | 2000 |
| 4 | R2 = | 5,560 | 5,560 | 5,560 | 5,560 | 5560 |
| 5 | ladj = | 50.0E-6 | 50.0E-6 | 50.0E-6 | 50.0E-6 | 50.0E-6 |
| 6 | | | 5.003 | 5.003 | 5.003 | 5.003 |

Table 7
Combined Distribution Spreadsheet for Vout

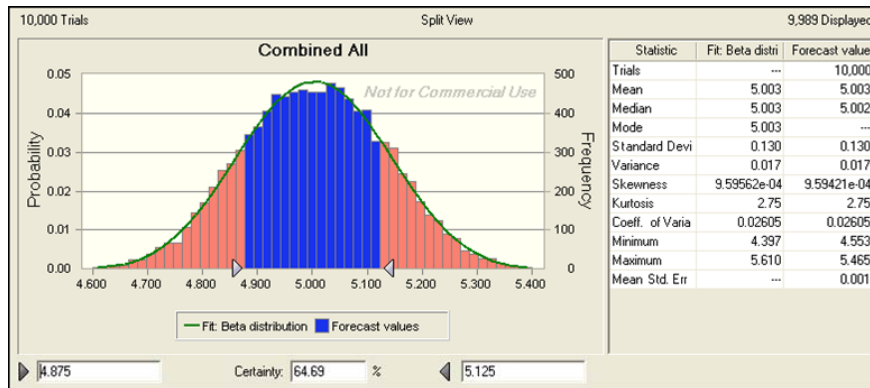

Figure 6
Combined Simulation Results

Minitab is also used to evaluate the quality LM117 voltage regulator using the Combine Simulation approach. The 10,000 run trial data points were imported into a Minitab project and Cp and Cpk values and Xbar and R charts were created. The Cp and Cpk values (shown in Figure 7) match but are very low, 0.33 and 0.32 respectively. This would imply that the design does not have adequate design margin and that there is a low probability that it can meet the $\pm 2.5\%$ design requirements. This would also imply that if the design limits were expanded to $\pm 12.5\%$, the Cp and Cpk values would approach the desired 1.67 value.

The Xbar and R charts (see Figure 8) show that there are special cause variations which will raise the concern about process. These charts are independent of the design limits and suggest that there are out of control processes relative to the design that should be investigated.

Additional information on the Minitab results can be found in Appendix F.

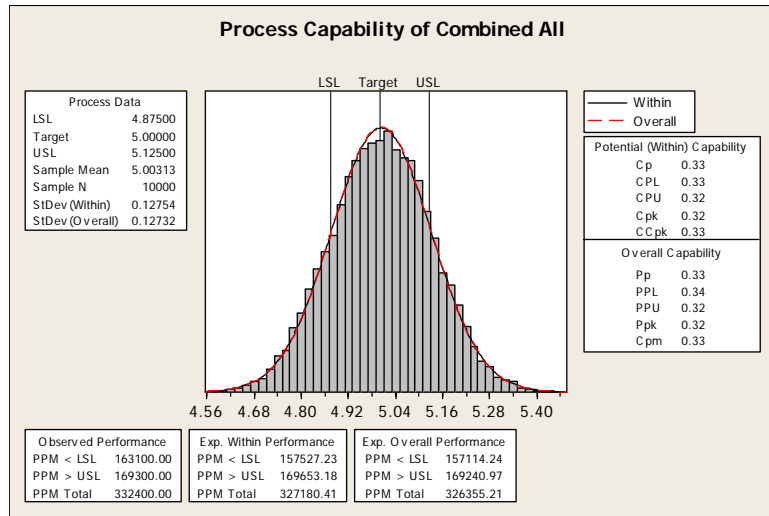

Figure 7
Combined Simulation
Cp and Cpk Performance

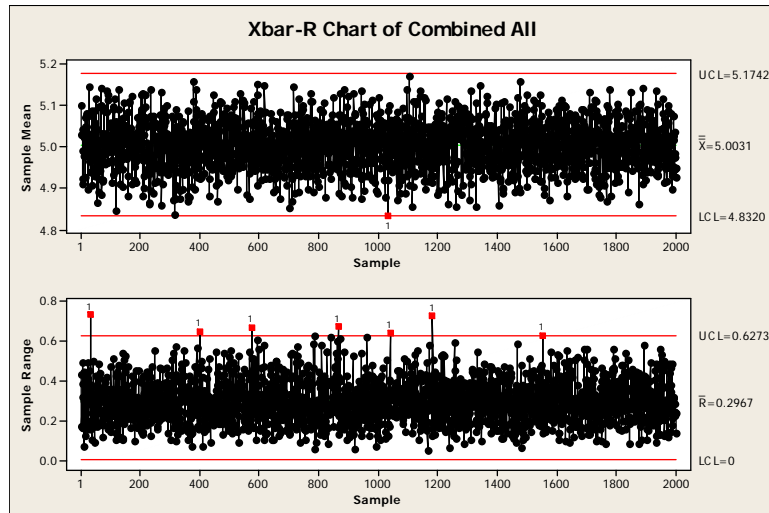

Figure 8
XBar and R Charts for
Combined Simulation Data

Conclusion

This paper has illustrated the benefits of Crystal Ball to simulate electronic circuits using various factor distributions. A new approach is suggested for the evaluation of risk assessment for electronics using Crystal Ball and Minitab that includes more realistic element distributions. The flexibility of the simulation tools has only touched on briefly in this paper. It is could be possible to expand and improve on the risk assessment approach to include; design optimization, element factor linkage, special cause variation investigation and BOL (Beginning of Life) and EOL (End of Life) measurements and calculations.

Appendix A

LM117 Datasheet Information

Based on engineering guidelines:

$$V_{ref}(\text{aging}) = 2\%$$

$$I_{adj}(\text{aging}) = 0\%$$

Purchase and temperature variations of V_{ref} and I_{adj} were derived based on the datasheet for the LM117⁸.

LM117 Electrical Characteristics

Specifications with standard type face are for $T_J = 25^\circ\text{C}$, and those with **boldface type** apply over full Operating Temperature Range. Unless otherwise specified, $V_{IN} - V_{OUT} = 5\text{V}$, and $I_{OUT} = 10\text{ mA}$.

| Parameter | Conditions | LM117 | | | |
|------------------------|---------------------------------------------------------------------------------------------------|-------------|-------------|-------------|---------------|
| | | Min | Typ | Max | Units |
| Reference Voltage | $3\text{V} \sim (V_{IN} - V_{OUT}) \sim 40\text{V}$, $10\text{ mA} \sim I_{OUT} \sim I_{MAX}$ | 1.20 | 1.25 | 1.30 | V |
| Adjustment Pin Current | | | 50 | 100 | μA |

Based on the engineering guidelines the maximum delta due to temperature will be used for worst case analysis and the maximum delta will be assumed to be symmetric around the nominal value.

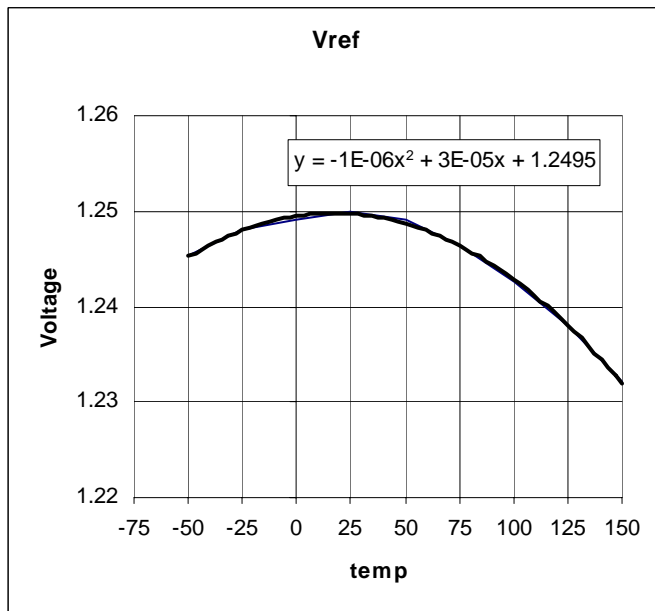

Figure A1 V_{ref} (temp)

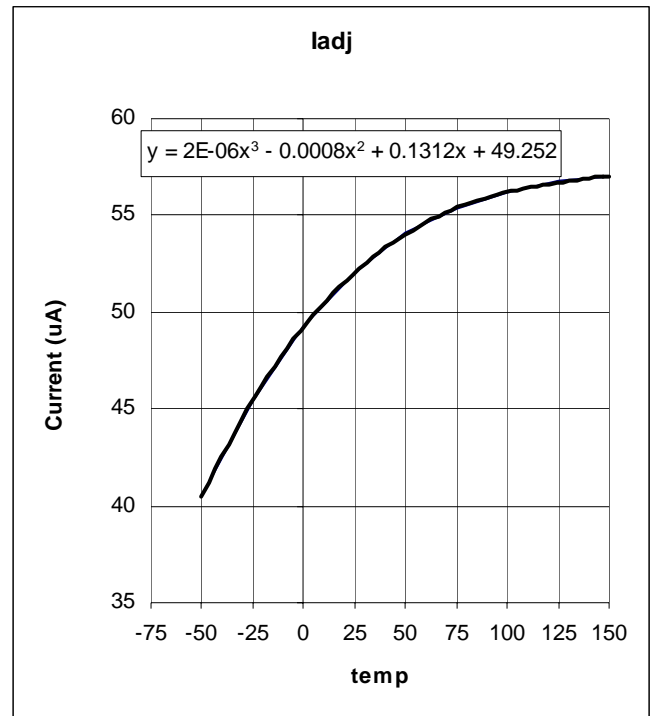

Figure A2 I_{adj} (temp)

⁸ LM117 Datasheet from National Semiconductor

Appendix A

Supplemental Design Details

To support the selection of R1 and R2, arbitrary closeness limits (LL and UL shown in Table A1) were used to measure the quality of the initial design to meet the exact design requirements. Then conditional formatting in Excel was used to determine if a calculated Vout was within the arbitrary closeness limits. All values for every R1 and R2 combinations were calculated with the “best” combination highlighted in Table A2.

| | |
|--------------|-------|
| ideal Vout = | 5.00 |
| LSL = | 5.125 |
| USL = | 4.875 |
| Tol = | 2.50% |
| BOL = | 0.02 |
| LL = | 4.980 |
| UL = | 5.020 |

**Table A1
Requirements and
Design Limits**

| | R2 | | | | | | | |
|-------|--------------|--------------|-------|-------|-------|--------------|-------|-------|
| R1 | 5,110 | 5,230 | 5,360 | 5,420 | 5,490 | 5,560 | 5,620 | 5,690 |
| 1,820 | 5.015 | 5.104 | 5.199 | 5.244 | 5.295 | 5.347 | 5.391 | 5.442 |
| 1,870 | 4.921 | 5.007 | 5.101 | 5.144 | 5.194 | 5.245 | 5.288 | 5.338 |
| 1,910 | 4.850 | 4.934 | 5.026 | 5.068 | 5.117 | 5.167 | 5.209 | 5.258 |
| 1,960 | 4.764 | 4.847 | 4.936 | 4.978 | 5.026 | 5.074 | 5.115 | 5.163 |
| 2,000 | 4.699 | 4.780 | 4.868 | 4.909 | 4.956 | 5.003 | 5.044 | 5.091 |
| 2,200 | 4.409 | 4.483 | 4.563 | 4.601 | 4.644 | 4.687 | 4.724 | 4.767 |
| 2,400 | 4.167 | 4.235 | 4.310 | 4.344 | 4.384 | 4.424 | 4.458 | 4.498 |
| 2,600 | 3.962 | 4.026 | 4.095 | 4.127 | 4.164 | 4.201 | 4.233 | 4.270 |

**Table A2
R1 & R2 Selection Matrix**

Appendix B

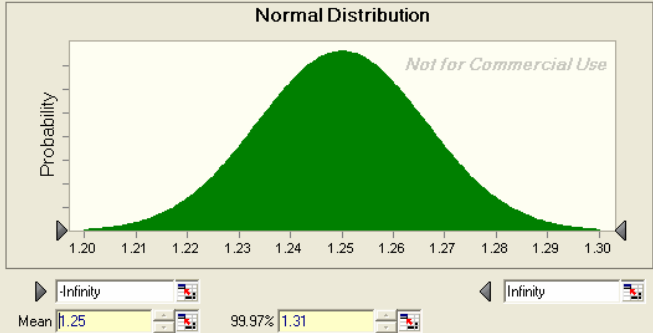
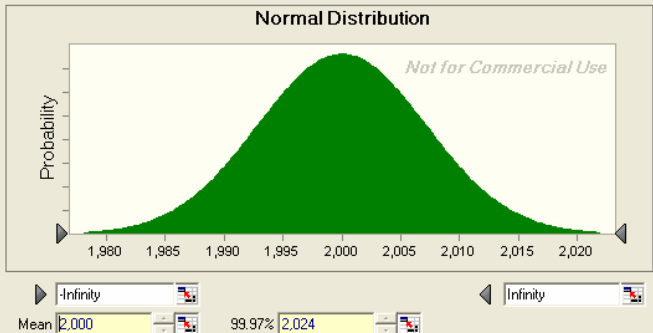
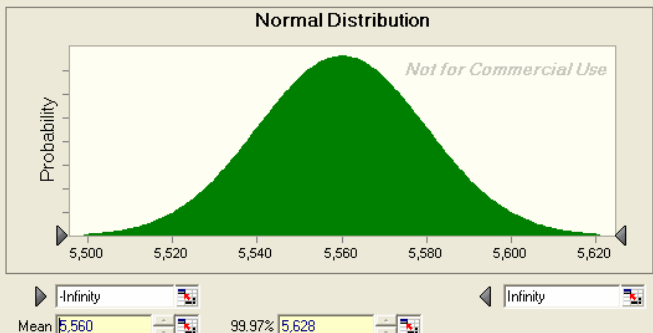
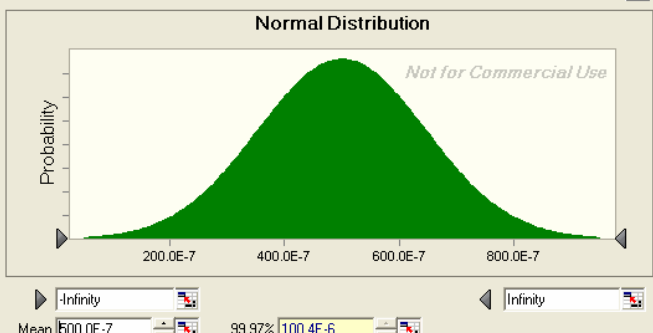
| Voltage Regulation Factors | Combined Distributions using RSS Approach |
|----------------------------------------------------------------------------------------------------------------------------------------------------------------------|--------------------------------------------------------------------------------------|
| <p>Vref distribution is the RSS of</p> <p>4% Purchase 0.3% due to Temperature 2% for Aging RSS = 4.48%</p> <p>Nominal = 1.25V Max = 1.31V</p> |  |
| <p>R1 distribution is the RSS of</p> <p>1% Purchase 0.5% due to Temperature 0.5% for Aging RSS = 1.22%</p> <p>Nominal = 2,000Ω Max = 2,024Ω</p> |  |
| <p>R2 distribution is the RSS of</p> <p>1% Purchase 0.5% due to Temperature 0.5% for Aging RSS = 1.22%</p> <p>Nominal = 5,560Ω Max = 5,628Ω</p> |  |
| <p>Iadj distribution is the RSS of</p> <p>100% Purchase 12.62% due to Temperature 0% for Aging RSS = 100.79%</p> <p>Nominal = 50μA Max = 100.4μA</p> |  |

$$RSS = \sqrt{(purchase_tol)^2 + (temp_tol)^2 + (aging_tol)^2}$$

Appendix B

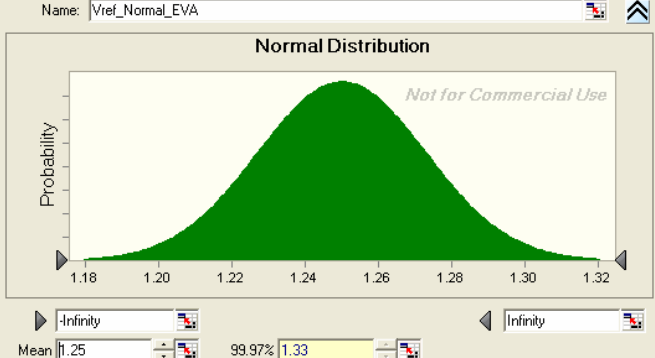
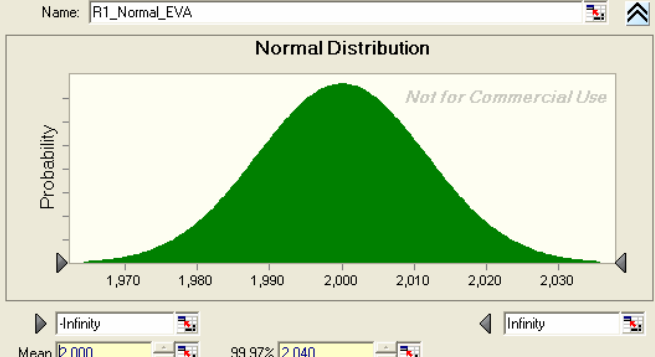
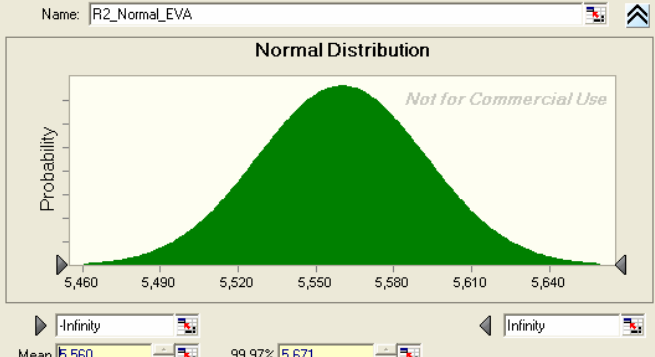
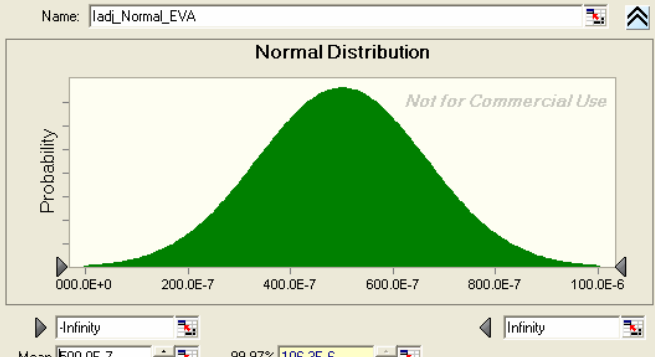
| Voltage Regulation Factors | Combined Distributions using EVA Approach |
|----------------------------------------------------------------------------------------------------------------------------------------------------------------------|--------------------------------------------------------------------------------------|
| <p>Vref distribution is the EVA of</p> <p>4% Purchase 0.3% due to Temperature 2% for Aging EVA = 6.3%</p> <p>Nominal = 1.25V Max = 1.33V</p> |  |
| <p>R1 distribution is the EVA of</p> <p>1% Purchase 0.5% due to Temperature 0.5% for Aging EVA = 2%</p> <p>Nominal = 2,000Ω Max = 2,040Ω</p> |  |
| <p>R2 distribution is the EVA of</p> <p>1% Purchase 0.5% due to Temperature 0.5% for Aging EVA = 2%</p> <p>Nominal = 5,560Ω Max = 5,671Ω</p> |  |
| <p>Iadj distribution is the EVA of</p> <p>100% Purchase 12.62% due to Temperature 0% for Aging EVA = 112.62%</p> <p>Nominal = 50μA Max = 106.3μA</p> |  |

$$EVA = \sum (purchase_tol) + (temp_tol) + (aging_tol)$$

Appendix B

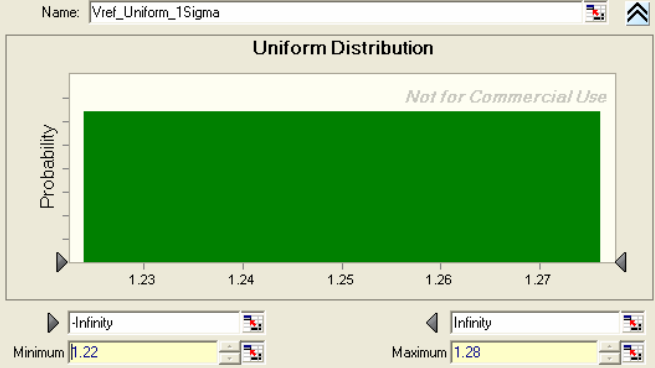
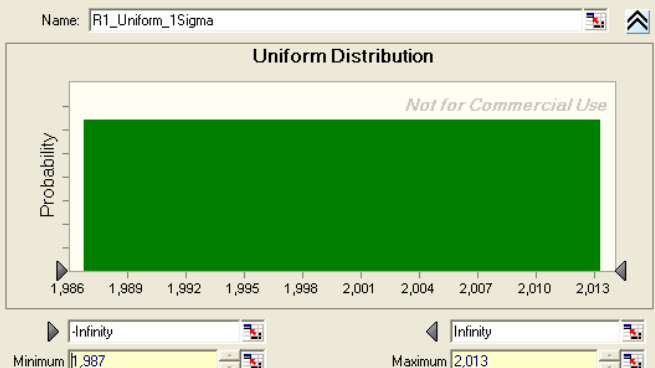
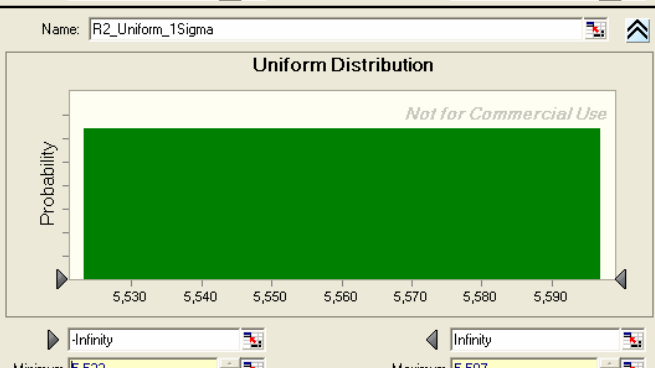
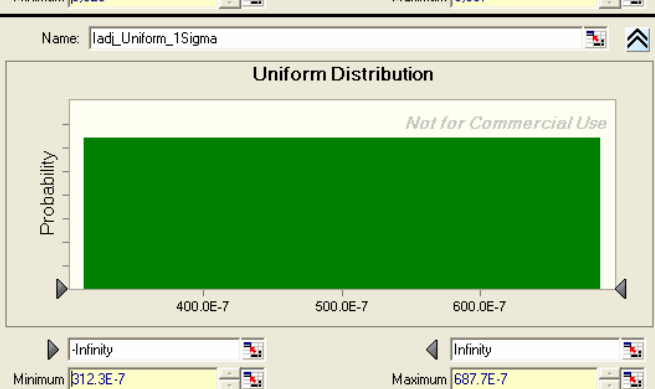
| Voltage Regulation Factors | Combined Distributions using 1 Sigma Approach |
|-------------------------------------------------------------------------------------------------------------------------------------------------------|--------------------------------------------------------------------------------------|
| <p>Vref distribution is the 1 Sigma of</p> <p>4% Purchase 0.3% due to Temperature 2% for Aging</p> <p>Min = 1.22V Max = 1.28V</p> |  |
| <p>R1 distribution is the 1 Sigma of</p> <p>1% Purchase 0.5% due to Temperature 0.5% for Aging</p> <p>Min = 1,987Ω Max = 2,013Ω</p> |  |
| <p>R2 distribution is the 1 Sigma of</p> <p>1% Purchase 0.5% due to Temperature 0.5% for Aging</p> <p>Min = 5,523Ω Max = 5,597Ω</p> |  |
| <p>Iadj distribution is the 1 Sigma of</p> <p>100% Purchase 12.62% due to Temperature 0% for Aging</p> <p>Min = 31.23μA Max = 68.77μA</p> |  |

$$1_Sigma = \frac{EVA}{3}$$

Appendix B

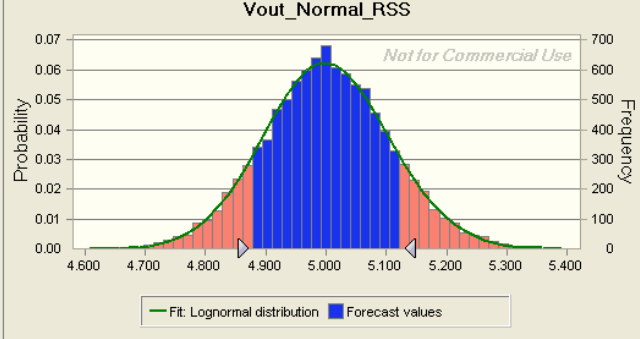
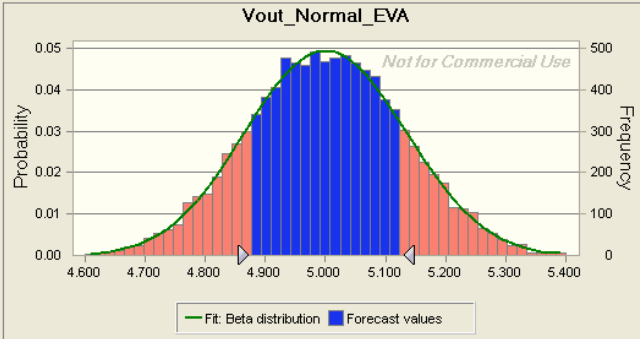
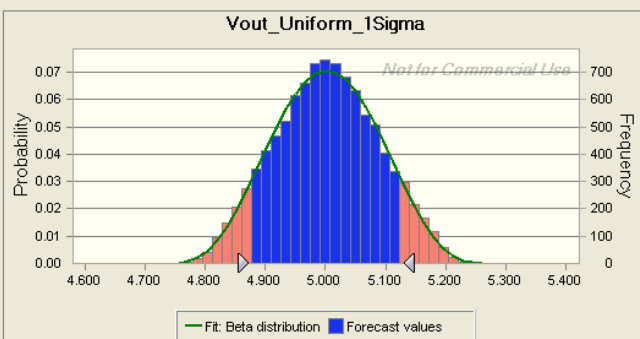
| Comments | Vout Regulated Voltage based on 10,000 run Crystal Ball simulation | | | | | | | | | | | | | | | | | | | | | | | | | | | | | | | | | | | | | | | |
|----------------------------------------------------------------------------------------------------------------------------|---------------------------------------------------------------------------------------------------------------------------------------------------------------------------------------------------------------------------------------------------------------------------------------------------------------------------------------------------------------------------------------------------------------------------------------------------------------------------------------------------------------------------------------------------------------------------------------------------------------------------------------------------------------------------------------------------------------------------------------------------------------------------------------------------------------------------------------------------------------------------------------------------------------------------------------------------------------------------------------------------------------------------------------------------------------------------------------------------------------------------------------------------------------------------------------------------------------------------------------------------------------------------|----------------|------------------|----------------|--------|-----|--------|------|-------|-------|--------|-------|-------|------|-------|-----|---------------|-------|-------|----------|-------|-------|----------|---------|---------|----------|------|------|-----------------|---------|---------|---------|-------|-------|---------|----------|-------|---------------|-----|-------|
| <p>The RSS approach shows that there is the high likelihood that the design would meet the design requirements.</p> | <div style="display: flex; justify-content: space-between;"> 10,000 Trials Split View 10,000 Displayed </div>  <table border="1" data-bbox="1187 268 1479 604"> <thead> <tr> <th>Statistic</th> <th>Fit: Lognormal</th> <th>Forecast value</th> </tr> </thead> <tbody> <tr><td>Trials</td><td>...</td><td>10,000</td></tr> <tr><td>Mean</td><td>5.001</td><td>5.001</td></tr> <tr><td>Median</td><td>5.000</td><td>5.000</td></tr> <tr><td>Mode</td><td>4.998</td><td>...</td></tr> <tr><td>Standard Devi</td><td>0.104</td><td>0.104</td></tr> <tr><td>Variance</td><td>0.011</td><td>0.011</td></tr> <tr><td>Skewness</td><td>0.06248</td><td>0.02997</td></tr> <tr><td>Kurtosis</td><td>3.01</td><td>3.06</td></tr> <tr><td>Coeff. of Varia</td><td>0.02082</td><td>0.02082</td></tr> <tr><td>Minimum</td><td>0.000</td><td>4.611</td></tr> <tr><td>Maximum</td><td>Infinity</td><td>5.384</td></tr> <tr><td>Mean Std. Err</td><td>...</td><td>0.001</td></tr> </tbody> </table> <div style="display: flex; justify-content: space-between; margin-top: 10px;"> 4.875 Certainty: 77.03 % 5.125 </div> | Statistic | Fit: Lognormal | Forecast value | Trials | ... | 10,000 | Mean | 5.001 | 5.001 | Median | 5.000 | 5.000 | Mode | 4.998 | ... | Standard Devi | 0.104 | 0.104 | Variance | 0.011 | 0.011 | Skewness | 0.06248 | 0.02997 | Kurtosis | 3.01 | 3.06 | Coeff. of Varia | 0.02082 | 0.02082 | Minimum | 0.000 | 4.611 | Maximum | Infinity | 5.384 | Mean Std. Err | ... | 0.001 |
| Statistic | Fit: Lognormal | Forecast value | | | | | | | | | | | | | | | | | | | | | | | | | | | | | | | | | | | | | | |
| Trials | ... | 10,000 | | | | | | | | | | | | | | | | | | | | | | | | | | | | | | | | | | | | | | |
| Mean | 5.001 | 5.001 | | | | | | | | | | | | | | | | | | | | | | | | | | | | | | | | | | | | | | |
| Median | 5.000 | 5.000 | | | | | | | | | | | | | | | | | | | | | | | | | | | | | | | | | | | | | | |
| Mode | 4.998 | ... | | | | | | | | | | | | | | | | | | | | | | | | | | | | | | | | | | | | | | |
| Standard Devi | 0.104 | 0.104 | | | | | | | | | | | | | | | | | | | | | | | | | | | | | | | | | | | | | | |
| Variance | 0.011 | 0.011 | | | | | | | | | | | | | | | | | | | | | | | | | | | | | | | | | | | | | | |
| Skewness | 0.06248 | 0.02997 | | | | | | | | | | | | | | | | | | | | | | | | | | | | | | | | | | | | | | |
| Kurtosis | 3.01 | 3.06 | | | | | | | | | | | | | | | | | | | | | | | | | | | | | | | | | | | | | | |
| Coeff. of Varia | 0.02082 | 0.02082 | | | | | | | | | | | | | | | | | | | | | | | | | | | | | | | | | | | | | | |
| Minimum | 0.000 | 4.611 | | | | | | | | | | | | | | | | | | | | | | | | | | | | | | | | | | | | | | |
| Maximum | Infinity | 5.384 | | | | | | | | | | | | | | | | | | | | | | | | | | | | | | | | | | | | | | |
| Mean Std. Err | ... | 0.001 | | | | | | | | | | | | | | | | | | | | | | | | | | | | | | | | | | | | | | |
| <p>The EVA approach shows that there is the lowest likelihood that the design would meet the design requirements.</p> | <div style="display: flex; justify-content: space-between;"> 10,000 Trials Split View 9,983 Displayed </div>  <table border="1" data-bbox="1187 682 1479 1018"> <thead> <tr> <th>Statistic</th> <th>Fit: Beta distri</th> <th>Forecast value</th> </tr> </thead> <tbody> <tr><td>Trials</td><td>...</td><td>10,000</td></tr> <tr><td>Mean</td><td>5.001</td><td>5.001</td></tr> <tr><td>Median</td><td>5.000</td><td>5.000</td></tr> <tr><td>Mode</td><td>5.000</td><td>...</td></tr> <tr><td>Standard Devi</td><td>0.129</td><td>0.129</td></tr> <tr><td>Variance</td><td>0.017</td><td>0.017</td></tr> <tr><td>Skewness</td><td>0.01354</td><td>0.01354</td></tr> <tr><td>Kurtosis</td><td>2.88</td><td>2.88</td></tr> <tr><td>Coeff. of Varia</td><td>0.02589</td><td>0.02589</td></tr> <tr><td>Minimum</td><td>4.112</td><td>4.546</td></tr> <tr><td>Maximum</td><td>5.933</td><td>5.478</td></tr> <tr><td>Mean Std. Err</td><td>...</td><td>0.001</td></tr> </tbody> </table> <div style="display: flex; justify-content: space-between; margin-top: 10px;"> 4.875 Certainty: 66.06 % 5.125 </div> | Statistic | Fit: Beta distri | Forecast value | Trials | ... | 10,000 | Mean | 5.001 | 5.001 | Median | 5.000 | 5.000 | Mode | 5.000 | ... | Standard Devi | 0.129 | 0.129 | Variance | 0.017 | 0.017 | Skewness | 0.01354 | 0.01354 | Kurtosis | 2.88 | 2.88 | Coeff. of Varia | 0.02589 | 0.02589 | Minimum | 4.112 | 4.546 | Maximum | 5.933 | 5.478 | Mean Std. Err | ... | 0.001 |
| Statistic | Fit: Beta distri | Forecast value | | | | | | | | | | | | | | | | | | | | | | | | | | | | | | | | | | | | | | |
| Trials | ... | 10,000 | | | | | | | | | | | | | | | | | | | | | | | | | | | | | | | | | | | | | | |
| Mean | 5.001 | 5.001 | | | | | | | | | | | | | | | | | | | | | | | | | | | | | | | | | | | | | | |
| Median | 5.000 | 5.000 | | | | | | | | | | | | | | | | | | | | | | | | | | | | | | | | | | | | | | |
| Mode | 5.000 | ... | | | | | | | | | | | | | | | | | | | | | | | | | | | | | | | | | | | | | | |
| Standard Devi | 0.129 | 0.129 | | | | | | | | | | | | | | | | | | | | | | | | | | | | | | | | | | | | | | |
| Variance | 0.017 | 0.017 | | | | | | | | | | | | | | | | | | | | | | | | | | | | | | | | | | | | | | |
| Skewness | 0.01354 | 0.01354 | | | | | | | | | | | | | | | | | | | | | | | | | | | | | | | | | | | | | | |
| Kurtosis | 2.88 | 2.88 | | | | | | | | | | | | | | | | | | | | | | | | | | | | | | | | | | | | | | |
| Coeff. of Varia | 0.02589 | 0.02589 | | | | | | | | | | | | | | | | | | | | | | | | | | | | | | | | | | | | | | |
| Minimum | 4.112 | 4.546 | | | | | | | | | | | | | | | | | | | | | | | | | | | | | | | | | | | | | | |
| Maximum | 5.933 | 5.478 | | | | | | | | | | | | | | | | | | | | | | | | | | | | | | | | | | | | | | |
| Mean Std. Err | ... | 0.001 | | | | | | | | | | | | | | | | | | | | | | | | | | | | | | | | | | | | | | |
| <p>The 1 Sigma approach shows that there is the highest likelihood that the design would meet the design requirements.</p> | <div style="display: flex; justify-content: space-between;"> 10,000 Trials Split View 10,000 Displayed </div>  <table border="1" data-bbox="1187 1096 1479 1432"> <thead> <tr> <th>Statistic</th> <th>Fit: Beta distri</th> <th>Forecast value</th> </tr> </thead> <tbody> <tr><td>Trials</td><td>...</td><td>10,000</td></tr> <tr><td>Mean</td><td>5.002</td><td>5.002</td></tr> <tr><td>Median</td><td>5.002</td><td>5.002</td></tr> <tr><td>Mode</td><td>5.002</td><td>...</td></tr> <tr><td>Standard Devi</td><td>0.085</td><td>0.085</td></tr> <tr><td>Variance</td><td>0.007</td><td>0.007</td></tr> <tr><td>Skewness</td><td>0.00356</td><td>0.00356</td></tr> <tr><td>Kurtosis</td><td>2.5</td><td>2.5</td></tr> <tr><td>Coeff. of Varia</td><td>0.01703</td><td>0.01703</td></tr> <tr><td>Minimum</td><td>4.733</td><td>4.770</td></tr> <tr><td>Maximum</td><td>5.272</td><td>5.238</td></tr> <tr><td>Mean Std. Err</td><td>...</td><td>0.001</td></tr> </tbody> </table> <div style="display: flex; justify-content: space-between; margin-top: 10px;"> 4.875 Certainty: 84.39 % 5.125 </div> | Statistic | Fit: Beta distri | Forecast value | Trials | ... | 10,000 | Mean | 5.002 | 5.002 | Median | 5.002 | 5.002 | Mode | 5.002 | ... | Standard Devi | 0.085 | 0.085 | Variance | 0.007 | 0.007 | Skewness | 0.00356 | 0.00356 | Kurtosis | 2.5 | 2.5 | Coeff. of Varia | 0.01703 | 0.01703 | Minimum | 4.733 | 4.770 | Maximum | 5.272 | 5.238 | Mean Std. Err | ... | 0.001 |
| Statistic | Fit: Beta distri | Forecast value | | | | | | | | | | | | | | | | | | | | | | | | | | | | | | | | | | | | | | |
| Trials | ... | 10,000 | | | | | | | | | | | | | | | | | | | | | | | | | | | | | | | | | | | | | | |
| Mean | 5.002 | 5.002 | | | | | | | | | | | | | | | | | | | | | | | | | | | | | | | | | | | | | | |
| Median | 5.002 | 5.002 | | | | | | | | | | | | | | | | | | | | | | | | | | | | | | | | | | | | | | |
| Mode | 5.002 | ... | | | | | | | | | | | | | | | | | | | | | | | | | | | | | | | | | | | | | | |
| Standard Devi | 0.085 | 0.085 | | | | | | | | | | | | | | | | | | | | | | | | | | | | | | | | | | | | | | |
| Variance | 0.007 | 0.007 | | | | | | | | | | | | | | | | | | | | | | | | | | | | | | | | | | | | | | |
| Skewness | 0.00356 | 0.00356 | | | | | | | | | | | | | | | | | | | | | | | | | | | | | | | | | | | | | | |
| Kurtosis | 2.5 | 2.5 | | | | | | | | | | | | | | | | | | | | | | | | | | | | | | | | | | | | | | |
| Coeff. of Varia | 0.01703 | 0.01703 | | | | | | | | | | | | | | | | | | | | | | | | | | | | | | | | | | | | | | |
| Minimum | 4.733 | 4.770 | | | | | | | | | | | | | | | | | | | | | | | | | | | | | | | | | | | | | | |
| Maximum | 5.272 | 5.238 | | | | | | | | | | | | | | | | | | | | | | | | | | | | | | | | | | | | | | |
| Mean Std. Err | ... | 0.001 | | | | | | | | | | | | | | | | | | | | | | | | | | | | | | | | | | | | | | |

Appendix C

Define Forecast Filter

Define Forecast: Cell D2

Name: Bimodal R1

Units:

Forecast Window | Precision | Filter | Auto Extract

Set a filter on the forecast values

Include values in the range: 1998 to 2002

Exclude values in the range: 1998 to 2002

When filtering values for this forecast, remove values for the same trial from other forecasts too.

Filtering removes values from charts and statistical calculations. Values are not lost and can be restored by changing these settings.

OK Cancel Apply To... Defaults... Help

Subtracted 0.1% range around Nominal Resistor Value

7,805 Trials | Frequency View (Filtered Values) | 7,786 Displayed

Bimodal R1

Probability

Frequency

Infinity Certainty: 100.00 % Infinity

Define Forecast: Cell D3

Name: Bimodal R2

Units:

Forecast Window | Precision | Filter | Auto Extract

Set a filter on the forecast values

Include values in the range: 5554.4 to 5565.6

Exclude values in the range: 5554.4 to 5565.6

When filtering values for this forecast, remove values for the same trial from other forecasts too.

Filtering removes values from charts and statistical calculations. Values are not lost and can be restored by changing these settings.

OK Cancel Apply To... Defaults... Help

7,750 Trials | Frequency View (Filtered Values) | 7,736 Displayed

Bimodal R2

Probability

Frequency

Infinity Certainty: 100.00 % Infinity

6,034 Trials | Split View (Filtered Values) | 6,033 Displayed

Vout_Filter_Rs

Probability

Frequency

Fit: Normal distribution Forecast values

4.875 Certainty: 76.70 % 5.125

| Statistic | Fit: Normal dis | Forecast value |
|-----------------|-----------------|----------------|
| Trials | ... | 6,034 |
| Mean | 5.004 | 5.004 |
| Median | 5.004 | 5.005 |
| Mode | 5.004 | ... |
| Standard Devi | 0.105 | 0.105 |
| Variance | 0.011 | 0.011 |
| Skewness | 0.0 | -0.02437 |
| Kurtosis | 3 | 2.99 |
| Coeff. of Varia | 0.02095 | 0.02095 |
| Minimum | Infinity | 4.620 |
| Maximum | Infinity | 5.430 |
| Mean Std. Err | ... | 0.001 |
| Filtered Value | ... | 3.966 |

With the subtraction of the 0.1% resistor range around the nominal value the RSS simulation results do not changed much when compared to the previous RSS simulation.

Assume that a $\pm 0.1\%$ tolerance band around the nominal resistors is excluded based upon manufacturing screening. The results show that there will be very little impact on the performance of the circuit.

Appendix D

Aging Distribution Development

The specification for a M55342 resistor states that there is a $\pm 0.5\%$ variation in resistance after a 7 year duration. Likewise, based on previous estimates the Vref for a LM117 varies by $\pm 2\%$ over life. Using the Arrhenius Equation⁹ a part will vary in value logarithmically from beginning of life to end of life. A simple curve fit to two points using years and tolerance variation produces the following figures.

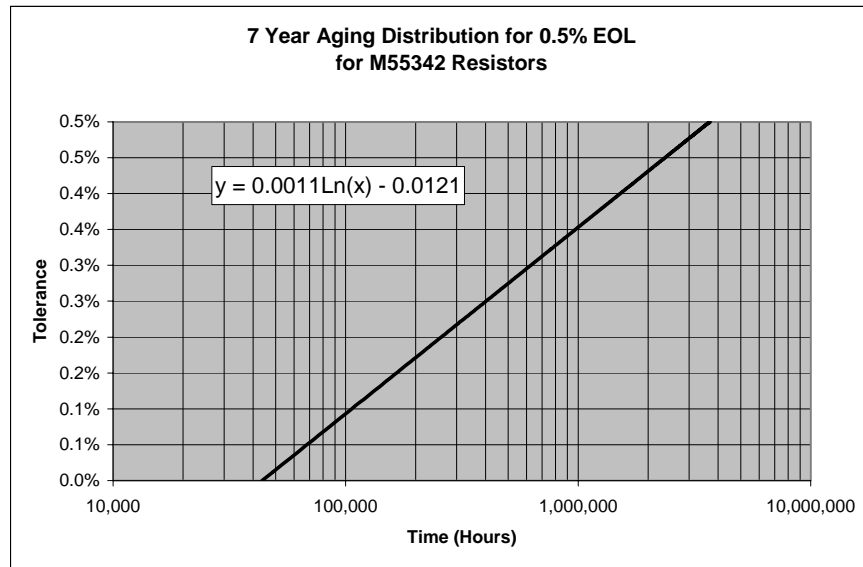

Figure D1

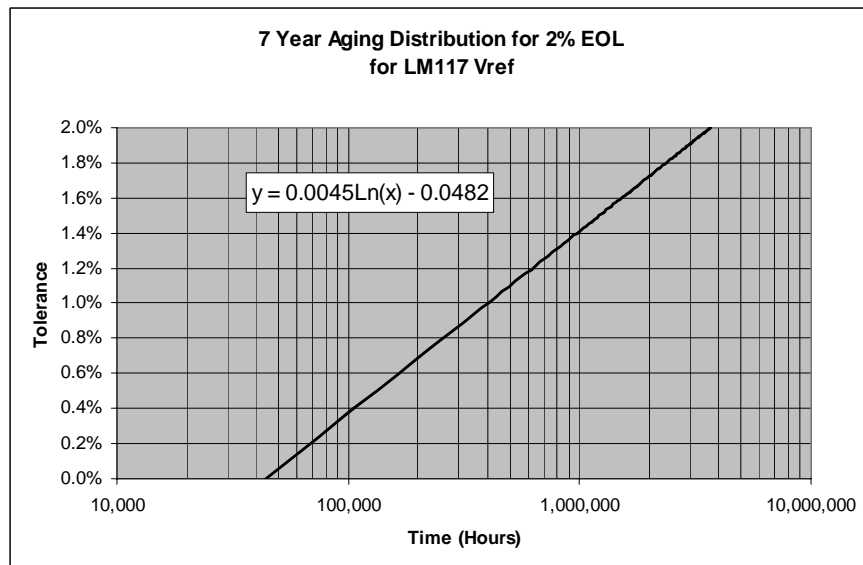

Figure D2

⁹ <http://www.shodor.org/UNChem/advanced/kin/arrhenius.html>

Appendix D

| Time (Hrs) | Resistance | Tolerance | Resistance | Tolerance |
|------------|------------|-----------|------------|-----------|
| 52560 | 2,000.29 | 0.01% | 1,999.71 | -0.01% |
| 105120 | 2,001.24 | 0.06% | 1,998.76 | -0.06% |
| 157680 | 2,002.13 | 0.11% | 1,997.87 | -0.11% |
| 210240 | 2,002.76 | 0.14% | 1,997.24 | -0.14% |
| 262800 | 2,003.25 | 0.16% | 1,996.75 | -0.16% |
| 315360 | 2,003.66 | 0.18% | 1,996.34 | -0.18% |
| 367920 | 2,003.99 | 0.20% | 1,996.01 | -0.20% |
| 420480 | 2,004.29 | 0.21% | 1,995.71 | -0.21% |
| 473040 | 2,004.55 | 0.23% | 1,995.45 | -0.23% |
| 525600 | 2,004.78 | 0.24% | 1,995.22 | -0.24% |
| 578160 | 2,004.99 | 0.25% | 1,995.01 | -0.25% |
| 630720 | 2,005.18 | 0.26% | 1,994.82 | -0.26% |
| 683280 | 2,005.36 | 0.27% | 1,994.64 | -0.27% |
| 735840 | 2,005.52 | 0.28% | 1,994.48 | -0.28% |
| 788400 | 2,005.67 | 0.28% | 1,994.33 | -0.28% |
| 840960 | 2,005.81 | 0.29% | 1,994.19 | -0.29% |
| 893520 | 2,005.95 | 0.30% | 1,994.05 | -0.30% |
| 946080 | 2,006.07 | 0.30% | 1,993.93 | -0.30% |
| 998640 | 2,006.19 | 0.31% | 1,993.81 | -0.31% |
| 1051200 | 2,006.30 | 0.32% | 1,993.70 | -0.32% |
| 1103760 | 2,006.41 | 0.32% | 1,993.59 | -0.32% |
| 1156320 | 2,006.51 | 0.33% | 1,993.49 | -0.33% |
| 1208880 | 2,006.61 | 0.33% | 1,993.39 | -0.33% |
| 1261440 | 2,006.71 | 0.34% | 1,993.29 | -0.34% |
| 1314000 | 2,006.79 | 0.34% | 1,993.21 | -0.34% |
| 1366560 | 2,006.88 | 0.34% | 1,993.12 | -0.34% |
| 1419120 | 2,006.96 | 0.35% | 1,993.04 | -0.35% |
| 1471680 | 2,007.04 | 0.35% | 1,992.96 | -0.35% |
| 1524240 | 2,007.12 | 0.36% | 1,992.88 | -0.36% |
| 1576800 | 2,007.20 | 0.36% | 1,992.80 | -0.36% |
| 1629360 | 2,007.27 | 0.36% | 1,992.73 | -0.36% |
| 1681920 | 2,007.34 | 0.37% | 1,992.66 | -0.37% |
| 1734480 | 2,007.41 | 0.37% | 1,992.59 | -0.37% |
| 1787040 | 2,007.47 | 0.37% | 1,992.53 | -0.37% |
| 1839600 | 2,007.54 | 0.38% | 1,992.46 | -0.38% |
| 1892160 | 2,007.60 | 0.38% | 1,992.40 | -0.38% |
| 1944720 | 2,007.66 | 0.38% | 1,992.34 | -0.38% |
| 1997280 | 2,007.72 | 0.39% | 1,992.28 | -0.39% |
| 2049840 | 2,007.77 | 0.39% | 1,992.23 | -0.39% |
| 2102400 | 2,007.83 | 0.39% | 1,992.17 | -0.39% |
| 2154960 | 2,007.88 | 0.39% | 1,992.12 | -0.39% |
| 2207520 | 2,007.94 | 0.40% | 1,992.06 | -0.40% |
| 2260080 | 2,007.99 | 0.40% | 1,992.01 | -0.40% |
| 2312640 | 2,008.04 | 0.40% | 1,991.96 | -0.40% |
| 2365200 | 2,008.09 | 0.40% | 1,991.91 | -0.40% |
| 2417760 | 2,008.14 | 0.41% | 1,991.86 | -0.41% |
| 2470320 | 2,008.18 | 0.41% | 1,991.82 | -0.41% |
| 2522880 | 2,008.23 | 0.41% | 1,991.77 | -0.41% |
| 2575440 | 2,008.28 | 0.41% | 1,991.72 | -0.41% |
| 2628000 | 2,008.32 | 0.42% | 1,991.68 | -0.42% |
| 2680560 | 2,008.36 | 0.42% | 1,991.64 | -0.42% |
| 2733120 | 2,008.41 | 0.42% | 1,991.59 | -0.42% |
| 2785680 | 2,008.45 | 0.42% | 1,991.55 | -0.42% |
| 2838240 | 2,008.49 | 0.42% | 1,991.51 | -0.42% |
| 2890800 | 2,008.53 | 0.43% | 1,991.47 | -0.43% |
| 2943360 | 2,008.57 | 0.43% | 1,991.43 | -0.43% |
| 2995920 | 2,008.61 | 0.43% | 1,991.39 | -0.43% |
| 3048480 | 2,008.65 | 0.43% | 1,991.35 | -0.43% |
| 3101040 | 2,008.68 | 0.43% | 1,991.32 | -0.43% |
| 3153600 | 2,008.72 | 0.44% | 1,991.28 | -0.44% |
| 3206160 | 2,008.76 | 0.44% | 1,991.24 | -0.44% |
| 3258720 | 2,008.79 | 0.44% | 1,991.21 | -0.44% |
| 3311280 | 2,008.83 | 0.44% | 1,991.17 | -0.44% |
| 3363840 | 2,008.86 | 0.44% | 1,991.14 | -0.44% |
| 3416400 | 2,008.90 | 0.44% | 1,991.10 | -0.44% |
| 3468960 | 2,008.93 | 0.45% | 1,991.07 | -0.45% |
| 3521520 | 2,008.96 | 0.45% | 1,991.04 | -0.45% |
| 3574080 | 2,009.00 | 0.45% | 1,991.00 | -0.45% |
| 3626640 | 2,009.03 | 0.45% | 1,990.97 | -0.45% |
| 3679200 | 2,009.06 | 0.45% | 1,990.94 | -0.45% |

Figure D3
2K Resistor Aging Info

| Time (Hrs) | Resistance | Tolerance | Resistance | Tolerance |
|------------|------------|-----------|------------|-----------|
| 52560 | 5,560.80 | 0.01% | 5,559.20 | -0.01% |
| 105120 | 5,563.44 | 0.06% | 5,556.56 | -0.06% |
| 157680 | 5,565.92 | 0.11% | 5,554.08 | -0.11% |
| 210240 | 5,567.68 | 0.14% | 5,552.32 | -0.14% |
| 262800 | 5,569.05 | 0.16% | 5,550.95 | -0.16% |
| 315360 | 5,570.16 | 0.18% | 5,549.84 | -0.18% |
| 367920 | 5,571.10 | 0.20% | 5,548.90 | -0.20% |
| 420480 | 5,571.92 | 0.21% | 5,548.08 | -0.21% |
| 473040 | 5,572.64 | 0.23% | 5,547.36 | -0.23% |
| 525600 | 5,573.29 | 0.24% | 5,546.71 | -0.24% |
| 578160 | 5,573.87 | 0.25% | 5,546.13 | -0.25% |
| 630720 | 5,574.40 | 0.26% | 5,545.60 | -0.26% |
| 683280 | 5,574.89 | 0.27% | 5,545.11 | -0.27% |
| 735840 | 5,575.34 | 0.28% | 5,544.66 | -0.28% |
| 788400 | 5,575.77 | 0.28% | 5,544.23 | -0.28% |
| 840960 | 5,576.16 | 0.29% | 5,543.84 | -0.29% |
| 893520 | 5,576.53 | 0.30% | 5,543.47 | -0.30% |
| 946080 | 5,576.88 | 0.30% | 5,543.12 | -0.30% |
| 998640 | 5,577.21 | 0.31% | 5,542.79 | -0.31% |
| 1051200 | 5,577.53 | 0.32% | 5,542.47 | -0.32% |
| 1103760 | 5,577.82 | 0.32% | 5,542.18 | -0.32% |
| 1156320 | 5,578.11 | 0.33% | 5,541.89 | -0.33% |
| 1208880 | 5,578.38 | 0.33% | 5,541.62 | -0.33% |
| 1261440 | 5,578.64 | 0.34% | 5,541.36 | -0.34% |
| 1314000 | 5,578.89 | 0.34% | 5,541.11 | -0.34% |
| 1366560 | 5,579.13 | 0.34% | 5,540.87 | -0.34% |
| 1419120 | 5,579.36 | 0.35% | 5,540.64 | -0.35% |
| 1471680 | 5,579.58 | 0.35% | 5,540.42 | -0.35% |
| 1524240 | 5,579.80 | 0.36% | 5,540.20 | -0.36% |
| 1576800 | 5,580.00 | 0.36% | 5,540.00 | -0.36% |
| 1629360 | 5,580.21 | 0.36% | 5,539.79 | -0.36% |
| 1681920 | 5,580.40 | 0.37% | 5,539.60 | -0.37% |
| 1734480 | 5,580.59 | 0.37% | 5,539.41 | -0.37% |
| 1787040 | 5,580.77 | 0.37% | 5,539.23 | -0.37% |
| 1839600 | 5,580.95 | 0.38% | 5,539.05 | -0.38% |
| 1892160 | 5,581.12 | 0.38% | 5,538.88 | -0.38% |
| 1944720 | 5,581.29 | 0.38% | 5,538.71 | -0.38% |
| 1997280 | 5,581.45 | 0.39% | 5,538.55 | -0.39% |
| 2049840 | 5,581.61 | 0.39% | 5,538.39 | -0.39% |
| 2102400 | 5,581.76 | 0.39% | 5,538.24 | -0.39% |
| 2154960 | 5,581.92 | 0.39% | 5,538.08 | -0.39% |
| 2207520 | 5,582.06 | 0.40% | 5,537.94 | -0.40% |
| 2260080 | 5,582.21 | 0.40% | 5,537.79 | -0.40% |
| 2312640 | 5,582.35 | 0.40% | 5,537.65 | -0.40% |
| 2365200 | 5,582.48 | 0.40% | 5,537.52 | -0.40% |
| 2417760 | 5,582.62 | 0.41% | 5,537.38 | -0.41% |
| 2470320 | 5,582.75 | 0.41% | 5,537.25 | -0.41% |
| 2522880 | 5,582.88 | 0.41% | 5,537.12 | -0.41% |
| 2575440 | 5,583.01 | 0.41% | 5,536.99 | -0.41% |
| 2628000 | 5,583.13 | 0.42% | 5,536.87 | -0.42% |
| 2680560 | 5,583.25 | 0.42% | 5,536.75 | -0.42% |
| 2733120 | 5,583.37 | 0.42% | 5,536.63 | -0.42% |
| 2785680 | 5,583.49 | 0.42% | 5,536.51 | -0.42% |
| 2838240 | 5,583.60 | 0.42% | 5,536.40 | -0.42% |
| 2890800 | 5,583.71 | 0.43% | 5,536.29 | -0.43% |
| 2943360 | 5,583.82 | 0.43% | 5,536.18 | -0.43% |
| 2995920 | 5,583.93 | 0.43% | 5,536.07 | -0.43% |
| 3048480 | 5,584.04 | 0.43% | 5,535.96 | -0.43% |
| 3101040 | 5,584.14 | 0.43% | 5,535.86 | -0.43% |
| 3153600 | 5,584.24 | 0.44% | 5,535.76 | -0.44% |
| 3206160 | 5,584.35 | 0.44% | 5,535.65 | -0.44% |
| 3258720 | 5,584.44 | 0.44% | 5,535.56 | -0.44% |
| 3311280 | 5,584.54 | 0.44% | 5,535.46 | -0.44% |
| 3363840 | 5,584.64 | 0.44% | 5,535.36 | -0.44% |
| 3416400 | 5,584.73 | 0.44% | 5,535.27 | -0.44% |
| 3468960 | 5,584.83 | 0.45% | 5,535.17 | -0.45% |
| 3521520 | 5,584.92 | 0.45% | 5,535.08 | -0.45% |
| 3574080 | 5,585.01 | 0.45% | 5,534.99 | -0.45% |
| 3626640 | 5,585.10 | 0.45% | 5,534.90 | -0.45% |
| 3679200 | 5,585.19 | 0.45% | 5,534.81 | -0.45% |

Figure D4
5.56K Resistor Aging Info

Appendix D

| Time (Hrs) | Vref | Tolerance | Vref | Tolerance |
|------------|--------|-----------|--------|-----------|
| 52560 | 1.2509 | 0.07% | 1.2491 | -0.07% |
| 105120 | 1.2548 | 0.38% | 1.2452 | -0.38% |
| 157680 | 1.2571 | 0.57% | 1.2429 | -0.57% |
| 210240 | 1.2587 | 0.70% | 1.2413 | -0.70% |
| 262800 | 1.2599 | 0.80% | 1.2401 | -0.80% |
| 315360 | 1.2610 | 0.88% | 1.2390 | -0.88% |
| 367920 | 1.2618 | 0.95% | 1.2382 | -0.95% |
| 420480 | 1.2626 | 1.01% | 1.2374 | -1.01% |
| 473040 | 1.2633 | 1.06% | 1.2367 | -1.06% |
| 525600 | 1.2638 | 1.11% | 1.2362 | -1.11% |
| 578160 | 1.2644 | 1.15% | 1.2356 | -1.15% |
| 630720 | 1.2649 | 1.19% | 1.2351 | -1.19% |
| 683280 | 1.2653 | 1.23% | 1.2347 | -1.23% |
| 735840 | 1.2657 | 1.26% | 1.2343 | -1.26% |
| 788400 | 1.2661 | 1.29% | 1.2339 | -1.29% |
| 840960 | 1.2665 | 1.32% | 1.2335 | -1.32% |
| 893520 | 1.2668 | 1.35% | 1.2332 | -1.35% |
| 946080 | 1.2672 | 1.37% | 1.2328 | -1.37% |
| 998640 | 1.2675 | 1.40% | 1.2325 | -1.40% |
| 1051200 | 1.2677 | 1.42% | 1.2323 | -1.42% |
| 1103760 | 1.2680 | 1.44% | 1.2320 | -1.44% |
| 1156320 | 1.2683 | 1.46% | 1.2317 | -1.46% |
| 1208880 | 1.2685 | 1.48% | 1.2315 | -1.48% |
| 1261440 | 1.2688 | 1.50% | 1.2312 | -1.50% |
| 1314000 | 1.2690 | 1.52% | 1.2310 | -1.52% |
| 1366560 | 1.2692 | 1.54% | 1.2308 | -1.54% |
| 1419120 | 1.2694 | 1.55% | 1.2306 | -1.55% |
| 1471680 | 1.2696 | 1.57% | 1.2304 | -1.57% |
| 1524240 | 1.2698 | 1.59% | 1.2302 | -1.59% |
| 1576800 | 1.2700 | 1.60% | 1.2300 | -1.60% |
| 1629360 | 1.2702 | 1.62% | 1.2298 | -1.62% |
| 1681920 | 1.2704 | 1.63% | 1.2296 | -1.63% |
| 1734480 | 1.2706 | 1.64% | 1.2294 | -1.64% |
| 1787040 | 1.2707 | 1.66% | 1.2293 | -1.66% |
| 1839600 | 1.2709 | 1.67% | 1.2291 | -1.67% |
| 1892160 | 1.2710 | 1.68% | 1.2290 | -1.68% |
| 1944720 | 1.2712 | 1.70% | 1.2288 | -1.70% |
| 1997280 | 1.2714 | 1.71% | 1.2286 | -1.71% |
| 2049840 | 1.2715 | 1.72% | 1.2285 | -1.72% |
| 2102400 | 1.2716 | 1.73% | 1.2284 | -1.73% |
| 2154960 | 1.2718 | 1.74% | 1.2282 | -1.74% |
| 2207520 | 1.2719 | 1.75% | 1.2281 | -1.75% |
| 2260080 | 1.2720 | 1.76% | 1.2280 | -1.76% |
| 2312640 | 1.2722 | 1.77% | 1.2278 | -1.77% |
| 2365200 | 1.2723 | 1.78% | 1.2277 | -1.78% |
| 2417760 | 1.2724 | 1.79% | 1.2276 | -1.79% |
| 2470320 | 1.2725 | 1.80% | 1.2275 | -1.80% |
| 2522880 | 1.2727 | 1.81% | 1.2273 | -1.81% |
| 2575440 | 1.2728 | 1.82% | 1.2272 | -1.82% |
| 2628000 | 1.2729 | 1.83% | 1.2271 | -1.83% |
| 2680560 | 1.2730 | 1.84% | 1.2270 | -1.84% |
| 2733120 | 1.2731 | 1.85% | 1.2269 | -1.85% |
| 2785680 | 1.2732 | 1.86% | 1.2268 | -1.86% |
| 2838240 | 1.2733 | 1.87% | 1.2267 | -1.87% |
| 2890800 | 1.2734 | 1.87% | 1.2266 | -1.87% |
| 2943360 | 1.2735 | 1.88% | 1.2265 | -1.88% |
| 2995920 | 1.2736 | 1.89% | 1.2264 | -1.89% |
| 3048480 | 1.2737 | 1.90% | 1.2263 | -1.90% |
| 3101040 | 1.2738 | 1.91% | 1.2262 | -1.91% |
| 3153600 | 1.2739 | 1.91% | 1.2261 | -1.91% |
| 3206160 | 1.2740 | 1.92% | 1.2260 | -1.92% |
| 3258720 | 1.2741 | 1.93% | 1.2259 | -1.93% |
| 3311280 | 1.2742 | 1.94% | 1.2258 | -1.94% |
| 3363840 | 1.2743 | 1.94% | 1.2257 | -1.94% |
| 3416400 | 1.2744 | 1.95% | 1.2256 | -1.95% |
| 3468960 | 1.2745 | 1.96% | 1.2255 | -1.96% |
| 3521520 | 1.2745 | 1.96% | 1.2255 | -1.96% |
| 3574080 | 1.2746 | 1.97% | 1.2254 | -1.97% |
| 3626640 | 1.2747 | 1.98% | 1.2253 | -1.98% |
| 3679200 | 1.2748 | 1.98% | 1.2252 | -1.98% |

Figure D5
LM117 Vref Aging Info

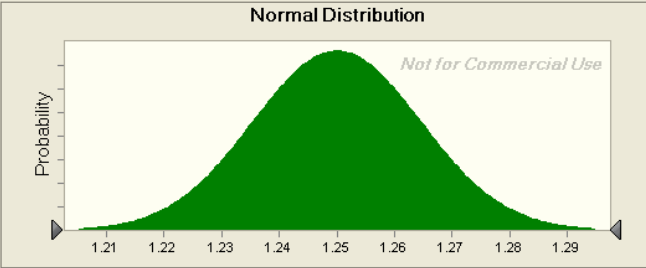
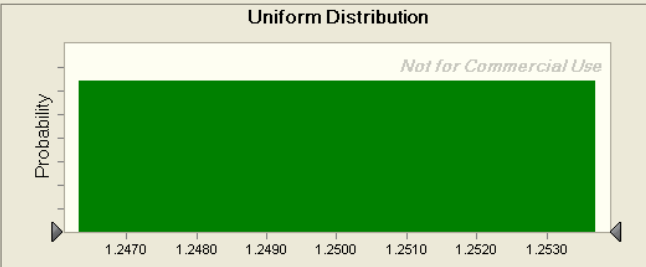
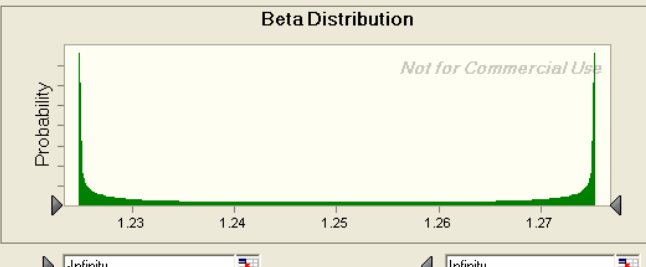

Appendix E

| Distribution Tolerances | Element Distributions for Vref |
|--------------------------------------------------------------------------------|-----------------------------------------------------------------------------------------------------------------------------------------------------------------------------------------------------------------------|
| <p>Purchase Variation = $\pm 4\%$ Normal Distribution</p> | <p>Name: Vref_Purchase_Normal</p> <p>Normal Distribution</p>  <p>Mean: 1.25 99.97%: 1.30</p> |
| <p>Temperature Variation = $\pm 0.3\%$ Uniform Distribution</p> | <p>Name: Vref_Temp_Uniform</p> <p>Uniform Distribution</p>  <p>Minimum: 1.2463 Maximum: 1.2537</p> |
| <p>Aging Variation = $\pm 2\%$ Beta Distribution</p> | <p>Name: Vref_Aging</p> <p>Beta Distribution</p>  <p>Minimum: 1.22 Maximum: 1.28</p> <p>Alpha: 0.3 Beta: 0.3</p> |

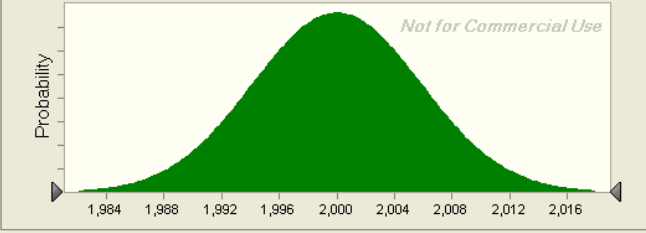
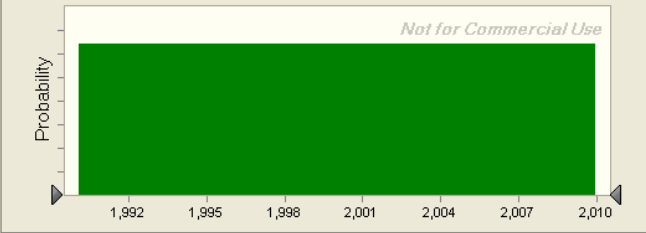
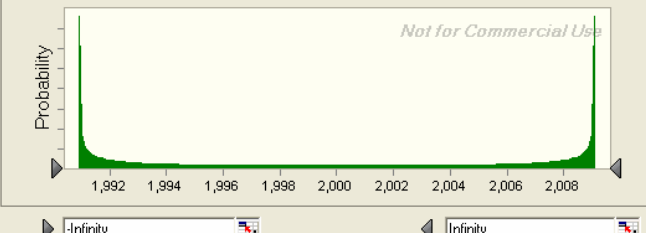
Appendix E

| Distribution Tolerances | Element Distributions for R1 |
|--------------------------------------------------------------------------------|--------------------------------------------------------------------------------------------------------------------------------------------------------------------------------------------------------------------------------------------------------------------------------------------------------------------------------------------------------|
| <p>Purchase Variation = 1% Normal Distribution</p> | <p>Name: R1_Purchase_Normal</p> <p>Normal Distribution</p>  <p>Probability</p> <p>1,984 1,988 1,992 1,996 2,000 2,004 2,008 2,012 2,016</p> <p>-Infinity Infinity</p> <p>Mean 2,000 99.97% 2,020</p> <p><i>Not for Commercial Use</i></p> |
| <p>Temperature Variation = $\pm 0.5\%$ Uniform Distribution</p> | <p>Name: R1_Temp_Uniform</p> <p>Uniform Distribution</p>  <p>Probability</p> <p>1,992 1,995 1,998 2,001 2,004 2,007 2,010</p> <p>-Infinity Infinity</p> <p>Minimum 1,990 Maximum 2,010</p> <p><i>Not for Commercial Use</i></p> |
| <p>Aging Variation = $\pm 0.5\%$ Beta Distribution</p> | <p>Name: R1_Aging</p> <p>Beta Distribution</p>  <p>Probability</p> <p>1,992 1,994 1,996 1,998 2,000 2,002 2,004 2,006 2,008</p> <p>-Infinity Infinity</p> <p>Minimum 1,991 Maximum 2,009</p> <p>Alpha 0.3 Beta 0.3</p> <p><i>Not for Commercial Use</i></p> |

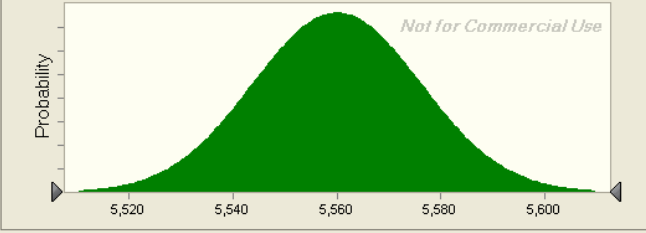
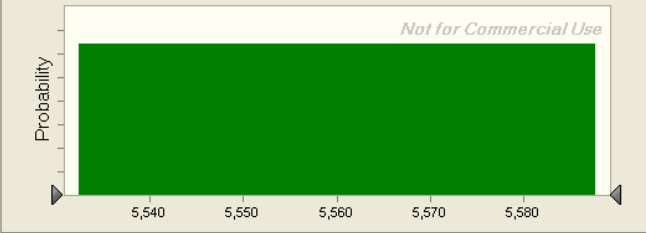
Appendix E

| Distribution Tolerances | Element Distributions for R2 |
|--------------------------------------------------------------------------------|-----------------------------------------------------------------------------------------------------------------------------------------------------------------------------------------------------------------------|
| <p>Purchase Variation = 1% Normal Distribution</p> | <p>Name: R2_Purchase_Normal</p> <p>Normal Distribution</p>  <p>Mean: 5,560 99.97%: 5,616</p> |
| <p>Temperature Variation = $\pm 0.5\%$ Uniform Distribution</p> | <p>Name: R2_Temp_Uniform</p> <p>Uniform Distribution</p>  <p>Minimum: 5,532 Maximum: 5,588</p> |
| <p>Aging Variation = $\pm 0.5\%$ Beta Distribution</p> | <p>Name: R2_Aging</p> <p>Beta Distribution</p>  <p>Minimum: 5,535 Maximum: 5,585</p> <p>Alpha: 0.3 Beta: 0.3</p> |

Appendix E

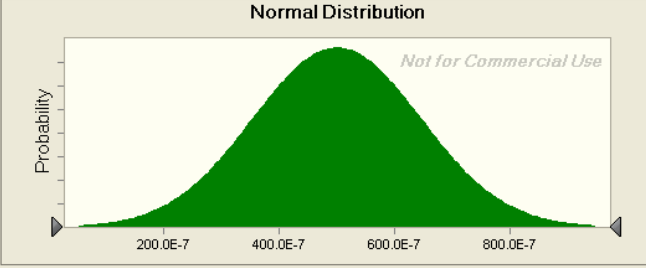
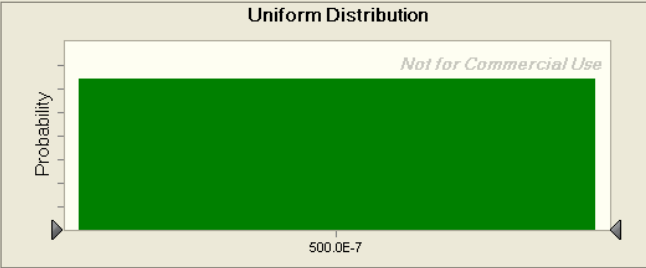
| Distribution Tolerances | Element Distributions for Iadj |
|----------------------------------------------------------------------------------|-------------------------------------------------------------------------------------------------------------------------------------------------------------------------------------------------------------------------------------------------------------------------------------|
| <p>Purchase Variation = 100% Normal Distribution</p> | <p>Name: Iadj_Purchase_Normal</p> <p>Normal Distribution</p>  <p>Probability</p> <p>200.0E-7 400.0E-7 600.0E-7 800.0E-7</p> <p>-Infinity Infinity</p> <p>Mean 500.0E-7 99.97% 100.0E-6</p> |
| <p>Temperature Variation = $\pm 12.62\%$ Uniform Distribution</p> | <p>Name: Iadj_Temp_Uniform</p> <p>Uniform Distribution</p>  <p>Probability</p> <p>500.0E-7</p> <p>-Infinity Infinity</p> <p>Minimum 436.9E-7 Maximum 563.1E-7</p> |

Appendix E

10,000 Run Simulation Results using Combined Distributions

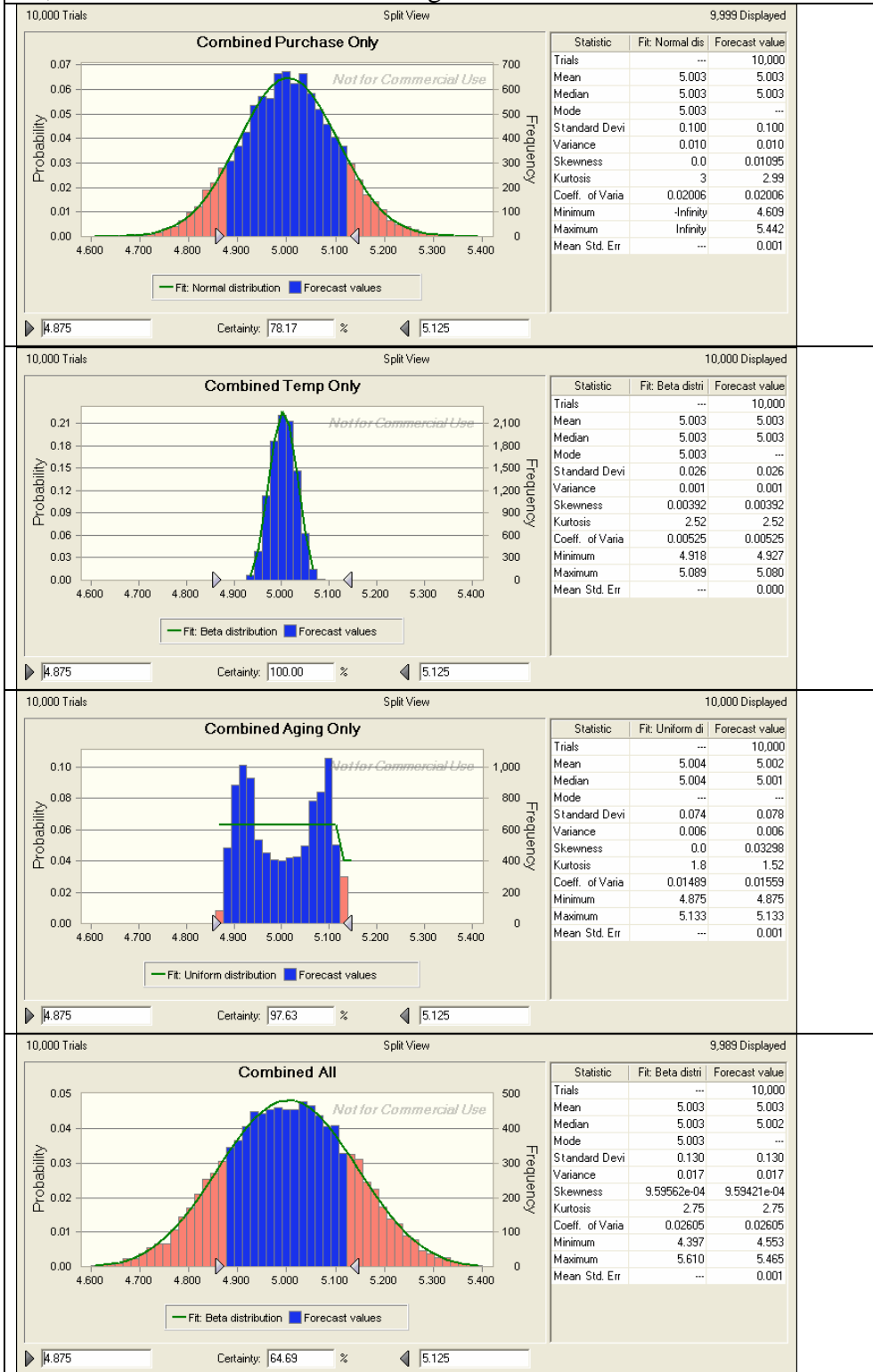

Appendix F

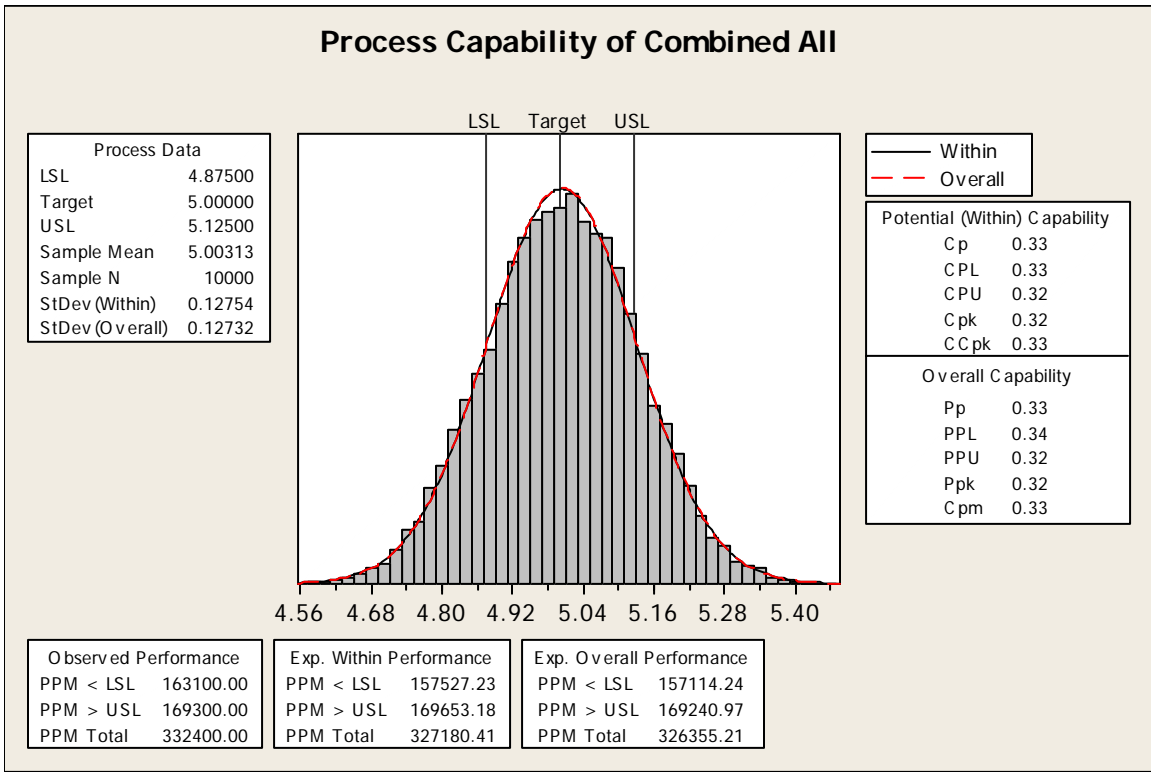

Figure F1

If the USL and LSL can be changed based on the Cp and Cpk then the design could meet $\pm 12.5\%$ tolerance range.

| | |
|--------------------|--------|
| stdev = | 0.1275 |
| new_stdev = | 0.6375 |
| UL = | 5.125 |
| LL = | 4.875 |
| new_UL = | 5.6375 |
| new_LL = | 4.3625 |

Figure F2

Appendix F

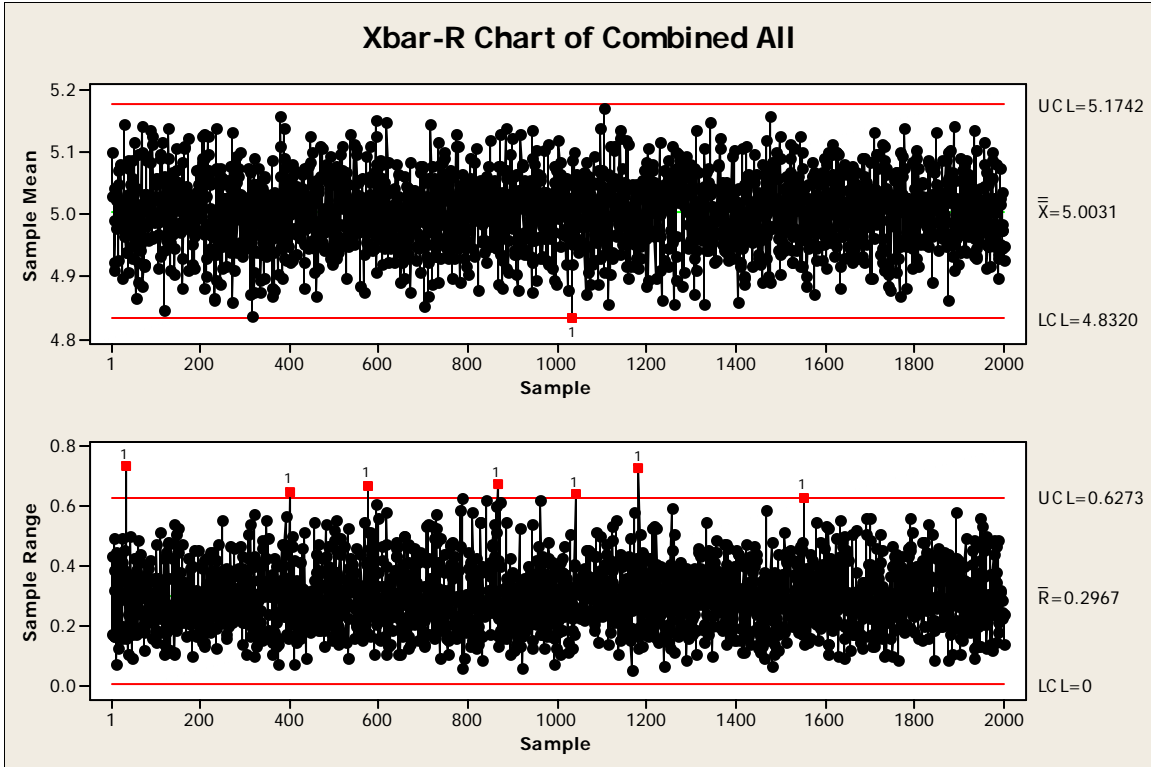

Figure F3

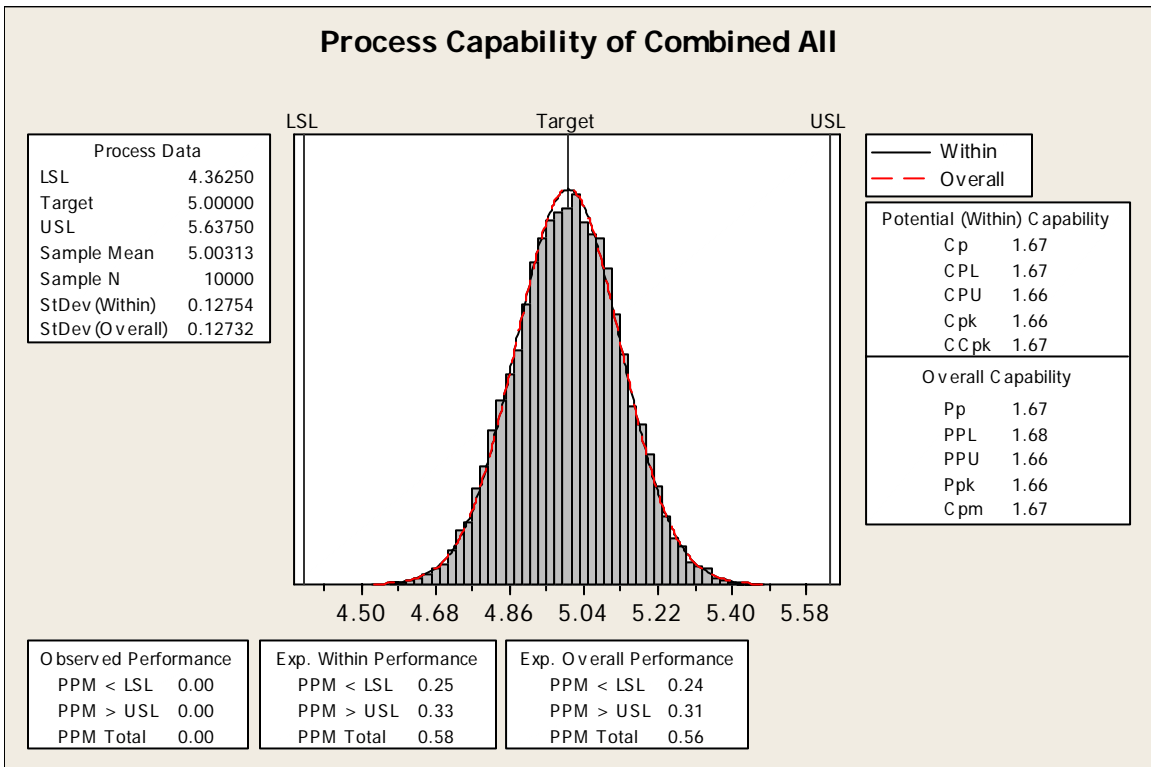

Figure F4